



genesis user's manual

(version 1.3)

Graphic Conventions

Blue decimals indicate sections in format of: chapter.section

20.3 The S (selectable) ranges of speed

= chapter 20 section 3

Green highlights indicate “how to” sections

14.7 To change fixed speed format

Underlined words indicate actions

Pull the latch outwards

Magenta numbers refer to other sections or chapters

see sections **4.2** and **16.2**

see *chapter 12*

Red italics indicate cautions and warnings

Do not use compressed air to clean Lens mount



Inspired by the past
Focused on the future



genesis user's manual

by benjamin b

Copyright Information

Copyright © 2007 Panavision Inc. All rights reserved. This document is not permitted to be distributed by anyone other than the employees of Panavision or its distributors. No part of this publication may be reproduced, transmitted, transcribed, stored in a retrieval system, or translated into any language in any form by any means without the prior written consent of Panavision. Prior written approval from Panavision must be obtained for any and all derivative works or aggregate works incorporating any of the information in this document, except as provided for under normal copyright law.

Disclaimer

Information in this document is provided solely for the user's information and, while thought to be accurate, is provided strictly "as is" and without warranty of any kind, including liability or warranties relating to fitness for a particular purpose, merchantability, or infringement of any patent, copyright or other intellectual property right. Panavision reserves the right to revise this publication and to make changes from time to time in the content hereof without obligation to notify any person of such revisions or changes. Specifications are subject to change without notice.

Panavision's obligations with respect to the products referenced herein are only as provided in Panavision's terms and conditions for rental. In no event shall Panavision, its employees or distributors be liable to you for any damages or losses, direct or indirect, arising from the use of any information contained in this document or the use of any products or services referenced within, or the information contained in, this manual.

Preface & thanks

This manual is designed for you to skip around, jumping to the chapters and sections of interest to you. The table of contents gives an overview, while each chapter head has a summary of its section contents. You can also use the find function of your pdf reader to find a topic, or a referenced section number. In a hurry? Try the Quick Reference at the back.

This is the first version of the Panavision Genesis manual. We need your feedback to make future versions better. Feel free to give us specific corrections, deletions and additions, or more general remarks. Let us know which topics you think we should expand on or add to in future versions. Also, we would like to include production stills in the manual. Let us know if you have some to offer. Please email your feedback to benjaminb.mail@free.fr.

This manual exists because of Andy Romanoff, who has guided the project from beginning to end. A big thank you goes to Andy for his leadership. Thank you also to Scott McDonald, Nolan Murdock and Andrew Young for all their careful work reading and correcting earlier versions. For final corrections, thanks to Dan Hammond, Mike Kovacevich, Laurence Nunn, and to Michael Chambliss, who also contributed seven photographs. Thank you to Tony Rivetti and Pierre-Hugues Galien for sharing their experience as ACs with the Genesis.

Finally, un grand merci to Philippe Valognes and to the team at Panavision Alga, and a big cheers to Peter Swarbrick and Panavision London for helping with equipment and knowledge.

Contents

Introduction

- 10 1. What do you want to know?
 - 16 2. Shooting Genesis: a production overview
-

The Genesis camera system

- 24 3. Cases
 - 30 4. Camera body tour
 - 52 5. Genesis Viewfinder
 - 66 6. SRW-1 VTR body tour
 - 74 7. VTR SRWC panel
 - 90 8. Mounting the SRW-1 & Loading Tape
 - 98 9. Powering the Genesis
 - 108 10. Video Monitoring
-

Camera menus

- 120 11. How to use the Camera LCD Menu
- 130 12. How to use Camera Viewfinder Menus
- 138 13. Six OPERATION Menus To Set
- 148 14. Setting the <MULTI FORMAT> Page
- 158 15. Setting USER Menus
- 164 16. Viewfinder Menus to Check Regularly

SRW-1 VTR menus

- 172 17. How to use VTR Menus
- 176 18. Time Code Settings
- 184 19. Audio Settings

Special Cases

- 196 20. About Variable Speed
- 210 21. Camera Separated from VTR

Before You Shoot

- 222 22. Exposure
- 232 23. Panavision recommended settings

Reference

- 236 24. Genesis technical overview
- 242 25. Post-production example
- 244 26. All the camera menus
- 266 27. All the VTR menus
- 274 28. Quick Reference

1. What do you want to know?

1.1 The manual overview

1.2 What do you want to know?

1.3 Panavision support

1.4 Panavision publications

1.5 Other resources

In a hurry? Try the Quick Reference at the back of the Manual

1.1 The manual overview

This manual is broken into seven parts:

Introduction

About the manual, and a production overview of the Genesis

The Genesis camera system

About the hardware: a tour of the Camera and VTR, with explanation of their controls and functions.

How to power the camera, and monitor the video image

Basic Camera menus

How to navigate the Genesis LCD and Viewfinder menus.

The basic menus you need to set and check.

SRW-1 menus

How to navigate the menus of the Sony SRW-1 VTR

The basic Audio and Time Code menu settings for the VTR.

Special cases

How to shoot variable speed and how to shoot with the Genesis camera separated from the SRW-1 VTR.

Before you shoot

About setting exposure for the Genesis

A summary of Panavision's recommended settings

Reference

A technical overview of the Genesis system

A brief example of post-production workflow

Comprehensive list of all the Camera and VTR menus

Quick reference

1.2 What do you want to know?

We encourage you to read as much of the manual as you have time for. However, if you don't have much time, here are some suggested starting places.

Camera assistants will need most of this manual, although the bulk of the final Reference section (chapters 24-27) is not essential.

If you are prepping for a first test you might want to read:

- Introduction - chapters 1-2

- Genesis Camera System – chapters 3-10

- Basic Camera menus – chapters 11-15

- Quick Reference – chapter 28

Cinematographers might want to read:

- Introduction - chapters 1-2

- Video Monitoring - chapter 10 –

- Exposure - chapter 22

- Panavision recommended settings – chapter 23

- Genesis technical overview – chapter 24

- Post-production overview – chapter 25

Directors might want to read:

- Introduction - chapters 1-2

- Video Monitoring - chapter 10

- Panavision recommended settings – chapter 23

- Post-production overview – chapter 25

Production managers might want to read:

- Introduction - chapters 1-2

- Panavision recommended settings – chapter 23

- Post-production overview – chapter 25

If you are working in post you might want to read:

Introduction - chapters 1-2

Chapter 20 – All about variable speed

Panavision recommended settings – chapter 23

Post-production overview – chapter 25

If you want to get a quick general idea of the Genesis, you might want to read:

Introduction - chapters 1-2

Genesis technical overview – chapter 24

Quick reference – chapter 28

1.3 Panavision support

Panavision offers support on many levels.

For the DP who is using Genesis for the first time, we offer the assistance of our technical marketing staff, a group of very experienced people stationed at Panavision locations around the world. They have years of experience with digital cameras and can help you determine what you can accomplish with Genesis. And just as with a film shoot, we can provide cameras in advance of your start date so you can do your testing to develop the project's look.

For the assistant, we offer training to ensure that your show will run smoothly from day one. For first time feature and TV show users, a technical marketing representative is often available to accompany you for the first few days of production, to answer any questions that may arise as you start working with the camera.

Contact Panavision representatives for more information about the Genesis. A listing of worldwide Panavision offices is available at:
<http://panavision.com/>

1.4 Panavision publications

The following publications may be useful for more information about the Genesis:

- Panavision Genesis FAQ

- Genesis Quick reference cards

- Panavision Gamma and Genesis Display Processor manual

- Genesis Menu Simulator (interactive web site)

These and other Panavision publications are available on-line at:

<http://www.panavision.com.au/Downloads/Downloads.htm>

<http://adi.panavision.com/gdp>

<http://ccbenjaminb.free.fr/download/>

1.5 Other resources

Sony

The brochure for the Sony SRW-1 on-board VTR can be found at the Panavision Australia web site:

<http://www.panavision.com.au/Downloads/DownloadsBrochuresOTHER.htm>

The manual for the Sony SRW-5000 and can be found at the Panavision Australia web site:

<http://www.panavision.com.au/Downloads/DownloadsManualsOTHER.htm>

Astro

You can download the full manual for the on-board Astro monitor DM 3005-A at:

<http://www.astro-systems-downloads.com>

http://www.astro-systems-downloads.com/HD/DM-3005A_v1.pdf

2. Shooting Genesis: a production overview

2.1 The Genesis is a film camera that shoots tape

2.2 Menus and maintenance

2.3 The choice of videotape

2.4 50 minute loads

2.5 FPS and progressive

2.6 Separating the Genesis and VTR

2.7 4:4:4 and 4:2:2

2.8 Variable speed

2.9 Shutter angles

2.10 Intercutting Genesis with film

2.11 Exposure Index

2.12 Color reference

2.13 Panalog and GDP

2.14 Pre-visualizing

2.1 The Genesis is a film camera that records digitally

Genesis was designed to work comfortably within the established practices of film crews. Genesis cameras take most of the standard Panavision 35mm accessories. Camera assistants familiar with film will find the same follow-focus, matte-box, filters and heads that they already use for 35mm. The SRW-1 VTR is mounted like a Panavision magazine either above or on the back of the camera.

Cinematographers and directors can call for the same lenses, and get the same look and depth of field as standard 35mm. Many directors of photography light for Genesis the same way they would light for an E.I. 500 Tungsten film stock.

Three key differences from the film experience are that HD monitors are incomparably sharper than 35mm video assist, that “reloading” 50 minute cassettes (or a Solid State Recorder) almost instantaneous, and that there is no delay before dailies are ready.

2.2 Menus and maintenance

Genesis is easy to use. The camera comes loaded with carefully chosen default settings that will work for most applications. During prep, the Camera Assistant will access a few menus to define the project frame rate, monitor frame lines and time code format.

On the set, Genesis is ready to record as soon as it is turned on and black balanced. The camera’s LCD screen allows for quick access to basic functions like shutter angle, film speed, film type or variable speed. When switching cassettes, the Camera Assistant will use a VTR menu to change time code.

Beyond normal cleaning there is very little field maintenance to be done on Genesis. Panavision provides information and training necessary to do simple field procedures

2.3 Recording

At present, most Genesis productions shoot on videotape using the on-board Sony SRW1 HDCAM SR recorder. Panavision sees 3 advantages to videotape:

1. Videotape recorders have a proven track record in the extremes of temperature, humidity and mechanical shock that are commonplace in today's productions.
2. The 50 minute duration allows for lengthy takes and rapid reloads.
3. Feature films require hundreds of terabytes of data, and videotape offers a very practical way to protect all your footage for the future.

Sony developed the SRW1 field recorder to directly interface to the Genesis and in that mode the VTR is seamlessly controlled and configured by the camera.

You also have the option to record the Genesis 4:4:4 Dual Link HD-SDI outputs to a Solid State Recorder, a separate hard drive, or other storage solutions. The Genesis signal can be recorded by any system that accepts dual link HDSDI.

2.4 HDCAM SR 50 minute loads

At 24 frames per second in standard SQ mode, the SRW-1 VTR records 50 minutes per HDCAM SR cassette. Just as with a film camera, you get more or less recording time at lower or higher speeds. At the top speed of 50 fps, the cassette recording time is halved.

2.5 FPS and progressive

The frame rate you choose will depend on the release requirements of your project. Genesis and SRW-1 offer the following fixed progressive frame rates: 23.98P – 24P – 25P – 29.97P and 50P.

Most American Genesis features have been shot at 23.98 fps. This allows for on-set playback of down-converted NTSC video with sync sound. Most US Genesis TV is shot at 23.98 fps, while European and Australian TV are shot at 25 fps.

It is also possible to shoot interlaced frame rates of 50I, 59.94I and 60I. The disadvantage of interlace is that the image is captured in two different moments of time, creating motion artifacts. Most productions do not shoot interlace unless intercutting with television cameras is required.

2.6 Separating the Genesis and VTR

If desired, the Genesis camera body and VTR can be separated, for example for a lighter Steadicam configuration, or inside a car. The Genesis can also be outfitted with a Solid State Recorder when a minimum weight and volume are required.

When the VTR is recording the signal from a separate camera, Panavision recommends that you shoot in the full color resolution of 4:4:4. This entails using the “Dual Link” connection using 2 BNC cables (as opposed to single cable 4:2:2).

2.7 The 4:4:4 and 4:2:2 formats

Panavision recommends that you record 4:4:4 if possible, even for a 4:2:2 finish. Simply put, the difference between 4:4:4 and 4:2:2 is that 4:4:4 allocates the same amount of information to the color and to the black and white portions of the image, while 4:2:2

allocates less information to color than black and white. Historically, the numbers 4 and 2 refer to the multiples of a reference frequency. The important thing to remember is the ratio of information.

2.8 Variable speed

Genesis cameras can shoot and record at any fixed speed from 1 to 50 fps. However, the camera does not ramp between speeds. The SRW-1 VTR does not record 4:4:4 at speeds over 29.97 fps. In order to accommodate the immense amount of data generated at speeds of 30 fps and above, the camera must be switched to 4:2:2.

Panavision recommends that you consult chapter 23 before recording variable speed. Note that, at present, the SRW-1 cannot record variable speed correctly when separated from the Genesis camera body.

2.9 Shutter angles

The Genesis shutter can be set at any angle between 3.8 and 360 degrees. Shutter angles above 200 degrees are new territory for the film cinematographer, yielding a different exposure, and a different rendering of motion. At 360 degrees (or "Shutter Off") the exposure time is twice as long as it is at 180 degrees. Therefore, the 360 degree shutter captures more motion blur, and more light, than 180 degrees.

You can use the shutter for artistic effect or to gain an additional stop of exposure or both. Some cinematographers experiment with a range of shutter angles between 180 and 360 to creatively modulate the resulting exposure gain and motion blur.

The effects of HMI lights are identical on Genesis and film, and require similar shutter settings. The advantage of Genesis is that

you can see any pulsing directly on the monitor. Panavision recommends testing if you plan to shoot with HMIs at unusual shutter angles.

2.10 Intercutting Genesis with film

Genesis and film intercut beautifully. This is partly due to Genesis' capturing a wider color space than standard video. Panavision recommends that you shoot tests with the emulsion you are planning to use and work with your post house to develop your strategy for handling the two materials.

2.11 Exposure Index

As with film, the EI setting is a technical and aesthetic choice made by the director of photography. Most DPs will set the Genesis between 500 and 640. However all cinematographers have noted that the Genesis is considerably more sensitive in the blacks than film.

In addition the sensitivity of the camera increases with bigger shutter angles: a 360 degrees shutter will yield twice as much exposure as 180 (with twice the motion blur).

2.12 Color reference

The Genesis does not use white balance, so it is not necessary to shoot a white card for proper operation, as with video cameras. Instead the director of photography chooses whether the Genesis is set for "Tungsten", "Daylight" or a given color temperature. Some cinematographers will also shoot a grey card or a chip chart as a color reference for post-production.

2.13 Panalog and GDP

The Genesis camera signal is transformed by a Panalog transfer curve designed by Panavision to maximize the latitude of the image for subsequent film or video finish. Simply put, the Panalog allocates more steps in the darks where the human eye is more discriminating, and fewer in the whites. Panalog also preserves Genesis' wide color gamut, a color space that is close to that of film.

Because of its wide latitude, the Panalog video output will not be properly displayed on a video monitor. The image may look washed out and underexposed. Some cinematographers simply adjust the brightness and contrast of their monitors to get a rough feel for the final image. However the Panavision GDP (Genesis Display Processor) offers a much better solution by applying a precise Viewing LUT (Color look-up table) to the signal for viewing on video monitors on the set or in dailies. This LUT correction can also be applied to the images going to the edit room.

2.14 Pre-visualizing

One of the benefits of shooting Genesis is that the footage does not require scanning for DI (digital intermediate) like film does.

Panavision strongly recommends that the cinematographer work closely with the post-production house at the outset of production to define the post workflow. Some DPs use Viewing LUTs defined by post houses and loaded into the Panavision GDP to pre-visualize the look of the release print on the set, and in HD projection of dailies.

3. Cases

3.1 A typical GENESIS CAMERA BODY Case

3.2 A typical GENESIS ACCESSORIES Case

3.3 A typical SONY VTR/PROCESSOR Case

3.4 A typical GENESIS BATTERY case

Note that all case contents may vary slightly in different territories to reflect different filmmaking cultures



3.1 A typical GENESIS CAMERA BODY Case might contain:

PV code	Description
GCB	GENESIS CAMERA BODY
HDCF	COLOR VIEWFINDER
HDAP	VIEWFINDER PIVOT
GEP	EYEPIECE TUBE
GVFM	VIEWFINDER MOUNT
GVFE	VIEWFINDER EXTENSION
GCH	CARRY HANDLE - SHORT
PCOB	O'CONNOR BASE PLATE 2
PCMU	CAMERA MOUNT - UNIVERSAL 2
MFFGB	MFF - GEAR BOX 1
MFFSK	MFF - SINGLE SPEED KNOB 2
MFFEX	MFF - EXTENSION TUBE 1
GPS	POWER SUPPLY 1
	STORAGE CASE – 14 REAR FILTERS
	12 REAR FILTER RETAINER BASES
	12 REAR FILTER RETAINERS
GCFT	REAR FILTER TOOL
FP1.575	FILTER PUNCH 1.575 (Pull from Existing Stock)
CS-GCP2.5	GENESIS POWER CABLE 2.5 METER
CS-GCP2.5R	GENESIS POWER CABLE,, 2.5 METER RIGHT ANGLE
CBLE-IECNA	IEC POWER CABLE

Some Genesis bodies come equipped with a different Sony viewfinder:

PV code	Description
HDSF	SONY COLOR VIEWFINDER 1
GWF	VIEWFINDER BRACKET 1
HDFA	VIEWFINDER ADAPTER 1

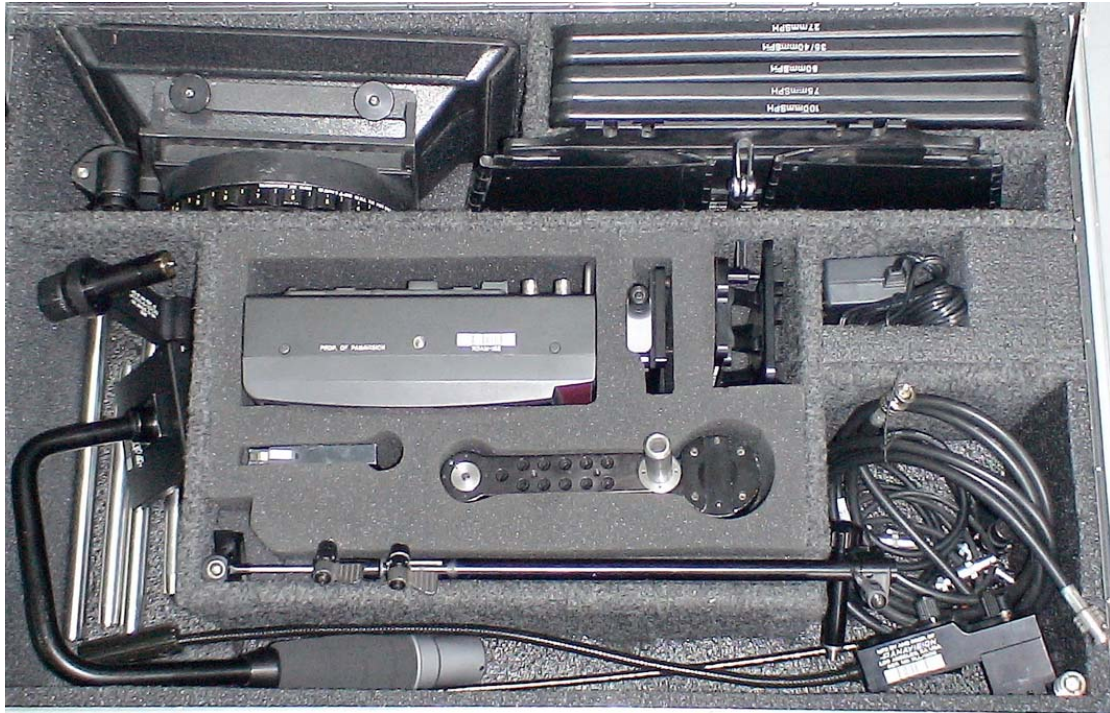

3.2 A typical GENESIS ACCESSORIES Case might contain:

PV code	Description
MB	MATTE BOX
138FR	138mm FILTER RING
FSE	SUNSHADE
MMBD	MONITOR BRACKET
VMBM	MONITOR BALL MOUNT
HDAM	ASTRO 6" HD MONITOR
HDMC-C	EVERTZ DOWNCONVERTER
EVPS	EVERTZ POWER SUPPLY
FXHL	SPEED CRANK
FFX	12" WHIP
FFX6	6" WHIP
EPL-M	EYEPIECE LEVELER
PDL	LENS LIGHT
SCAD	STEADICAM -REGULAR
GLMB	STEADICAM - LOW MODE
MXLSCT	STEADICAM TOP PLATE
GRB	IRIS ROD BRACKET - LONG
GHH	CARRY HANDLE - LONG
GCHB	CARRY HANDLE BRACKET
IRISROD	SET of 5" 7" 9" IRISRODS
MBM	SET of 16X9 MATTE BOX MATTE for 27 35 40 50 75 mm
CBLE-ZLP	2 ZOOM LENS POWER CABLE
CBLE-HDEM	2 ON-BOARD MONITOR POWER CABLES
CBLE-BNCHS	2 1 METER BNC
CBLE-IECNA	IEC POWER CABLE
CBLE-MCGP	2 12 VOLT CAMERA POWER TO EVERTZ



3.3 A typical SONY VTR/PROCESSOR Case might contain:

PV code	Description
SRW-1	SRW-1 BASIC VTR
SRWC	VTR CONTROL PANEL
SRPC	VTR - HD VIDEO PROCESSOR
GPS	VTR POWER SUPPLY
CS-SRW	CONTROL PANEL CABLE 18"
CS-SRWS	CONTROL PANEL CABLE SHORT
CS-SRWL	CONTROL PANEL CABLE LONG
CBLE-IECNA	IEC POWER CABLE
CBLE-12P	12 VOLT POWER CABLE
CBLE-BNCHS	2 1 METER BNC



3.4 A typical GENESIS BATTERY case might contain:

PV code	Description
14NM33	GENESIS BATTERY
GBC	GENESIS BATTERY CHARGER
	GENESIS BATTERY CHARGER CABLE
CBLE-IECNA	IEC POWER CABLE

4. Camera body tour

4.1 Camera Left side

4.2 hdrp connector

4.3 assign controls

4.4 record button & red LED

4.5 Image plane indicator

4.6 Left side LCD Panel

4.7 alarm indicator

4.8 display push button

4.9 see chapter 11 for other menu controls

4.10 Camera Front

4.11 Panavision lens mount

4.12 GRB iris rod bracket

4.13 Camera Right Side connectors

4.14 Camera Top – removing the handle

4.15 Camera Top VTR port

4.16 Camera Rear

4.17 GADC on Camera Rear

4.18 GDPL BNC BOX on Camera Rear

4.19 Camera Bottom

4.20 PCMU camera mount

4.1 Camera Left side



The camera left side contains the Menu and controls most frequently accessed by Camera Assistants: **1** **record** start/stop, **2** **assignable** switches, **3** the **LCD menu screen** and **4** the controls for **lcd** and **vf** menus. On top **5** and at the back **6** are 2 silver **latches** for the top and back VTR ports. There is also **7** a white image plane mark

4.2 hdrp connector

hdrp 10-pin Connector

plugs in to remote start/stop cables



4.3 assign controls

There are 3 **assignable** controls:

1 and **2** are up and down position of a switch

3 is a push button.

The Panavision default for these switches are:

1 FAN MAX - Used to cool off a camera in a hot environment between takes. See [16.6](#)

2 MONI CHAR ON/OFF – A quick way to get rid of menu characters on the MONITOR video output going out to the set.

3 REC REVIEW - The Record Review function automatically rewinds the tape and plays back the last 3 seconds of the last take, and then stops, cueing the tape for the next recording. Many Camera Assistants use REC REVIEW as a digital version of "checking the gate". Some Assistants will put a tail slate at the end of the take to easily distinguish between similar takes.

If you keep the REC REVIEW button pushed down the VTR will play the last 10 seconds of the last take.

The assignable switches are defined by page 8 of the Viewfinder OPERATION menu. See [12.11](#) and [16.2](#)

4.4 record button & red LED

record start/pause push button

Push once to start or stop recording. This function only works when the SRW-1 VTR is connected to the top or back VTR port of the camera.

record **red light** indicator

will turn on when camera is initializing after power on.

will blink while videotape comes up to speed, then turn a solid red during recording.



Recording is also indicated in the viewfinder by horizontal top and bottom bars

Also a red REC indicator appears with the one-line character display

4.5 Image plane indicator



The circle with the cross through it defines the image plane for focus position. Two hooks underneath the camera can be swiveled out for use with a tape to measure focus.

4.7 Left side LCD Panel



Green 2-Line LCD serves as a display of fps, shutter angle, voltage, film type and gain.

Below the LCD panel are an indicator and controls. Starting from the left side:

4.7 alarm indicator

The red **alarm** LED blinks to indicate that camera is initializing or is coming up to speed at the beginning of recording.

when on indicates either that there is a problem usually described in an error message on LCD panel.

Alarm LED will blink once when the on-board VTR is turned on or off.

4.8 display push button

Push this unlabeled **black push button** (to right of alarm LED) to change what is on the top line of the LCD display. There are 3 possibilities:

1. shutter degree, e.g. 180deg
2. 12 volt supply voltage and 24 volt supply voltage
3. Film type (Tungsten or Daylight) and Gain settings

push to clear error message on LCD panel

The bottom line of the LCD display shows the frame rate.

4.10 see chapter 11 for other menu controls

Please go to **Chapter 11** to get detailed information about the following switches and knob used to navigate **Menus** and quickly change key camera settings.:

status/cancel

menu vf/lcd

thumbwheel

4. 10 camera front

The Genesis front has a standard Panavision 35mm lens mount that will accept all Panavision spherical lenses.



The camera front has:

- A standard Panavision lens mount in the center, identical to the lens mount on Panaflex film cameras.
- A silvery bracket on top for viewfinder support
- A bottom black bracket for follow-focus support.
- To the left is the standard Panavision iris rod bracket support.
- The left side of the camera front contains 12V and 24V outputs
- There are also 4 connectors (labeled Focus, T-Stop and 2 Zoom) for future use.
- Above the lens mount are 2 Viewfinder connectors.

12V and 24V Lemo

Standard Panavision connectors to feed accessories. Most Panavision accessories will require 24 Volts.

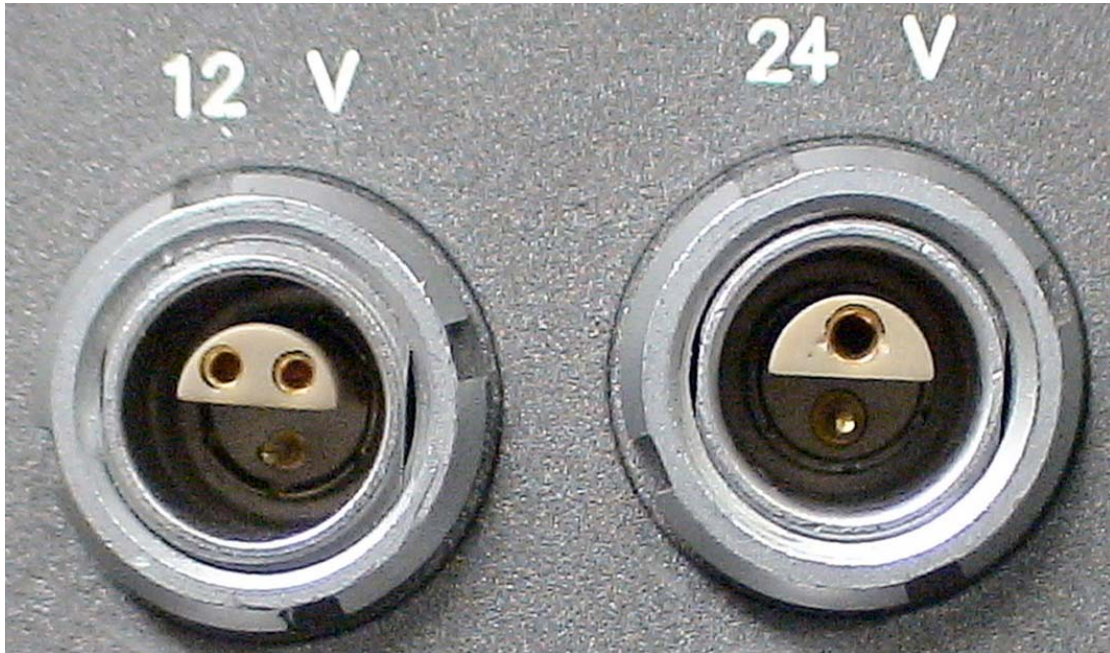

12V Lemos are 3-pin, while 24V Lemos are 2-pin

Panavision recommends using independent batteries for high current accessories, like spray deflectors.

The front power connectors will supply approximately 8 Amps.

When the connector draws too much current, it will shut down, indicating 12V NG or 24V NG on the LCD display. To reset, turn camera OFF and ON.

Z analog and **Z digital** multipin connectors

For future use

F and **T** multipin connectors

For future use

24 Volt output in center of iris rod bracket support
Standard Panavision Lemo connector to feed accessories

Viewfinder2 and **Viewfinder1** Multi-pin plugs.

Plug in Sony HD viewfinders.

Note that the characters are always on in Viewfinder2.

See [10.1](#) for more details.

4.11 Panavision lens mount

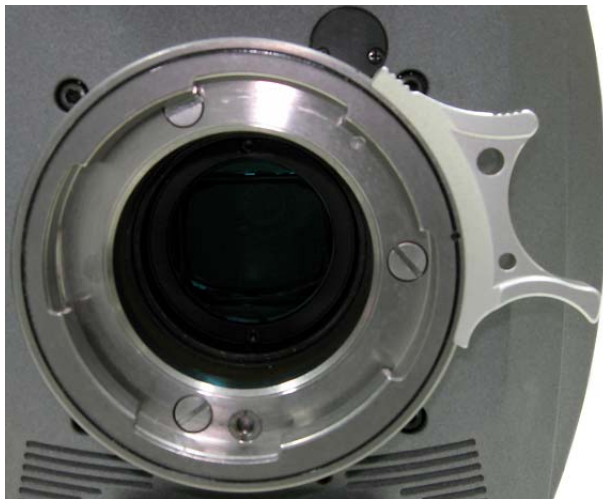

The Panavision **lens mount**

As with a Panavision film camera, rotate counter-clockwise to release cap or lens, and rotate clockwise to lock cap or lens snugly in place. Do not over-tighten.

WARNING

Never use compressed air in or near the Genesis lens mount as this could move dust inside the camera.

Use an anti-static brush instead

4.12 GRB iris rod bracket



When the **GRB** long iris rod bracket is fitted to the front of the camera, it provides two more power outlets: 24V and 12V.

4.13 Camera Right Side connectors

The right side of the Genesis camera has a large shuttered panel for ventilation, which should not be covered, or the camera may overheat.



There are 5 connectors on the bottom:



REMOTE OTHER 8-pin connector

This connector is sometimes labeled SONY, for Panavision technician access.

REMOTE RS 232 4-pin connector

Used to plug in Panavision Digital Link FTZAC unit.

POWER 8-pin connector

Panavision 8-pin plug for combined 12 Volt (for camera) and 24 Volt (for accessories). Connect to GPS power supply or Battery. Use only Panavision-supplied power cables.

METADATA BNC

For future transmission of metadata, e.g. lens or camera movement information.

MONITOR BNC

Main video output. HDSDI 4:2:2 1920 by 1080 pixel signal. Connect to on-board HD monitor and other on-set HD monitors.

Sometimes labeled HDSDI.



There is a focus tape hook that swivels out underneath the right side.

Some Genesis cameras have a focus tape hook only under left side.

4.15 camera top – removing the handle

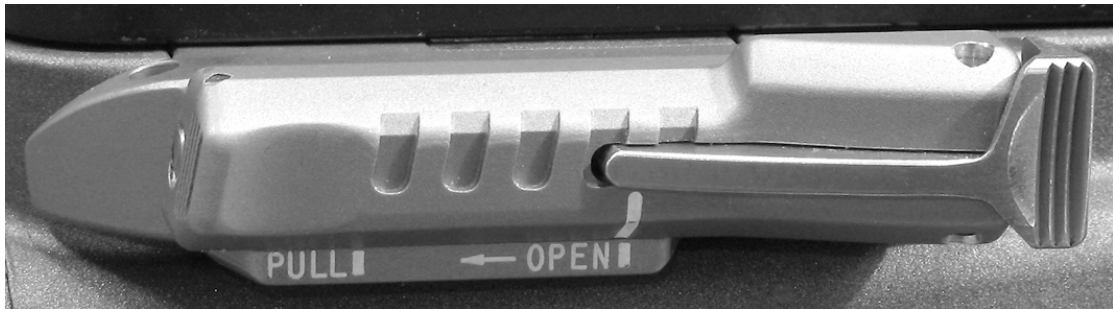

Close-up shot of the VTR port latch. There is one on each VTR port: top and rear.



The latch is unlocked by pushing down on the ridged pad at right, revealing a red stripe. The latch can then be slid leftwards before it can be pulled out.



In its case, the Genesis camera comes with the **GCH** handle in its top VTR port.

There is a silver port latch beneath the handle; there is an identical latch on the rear VTR port.

To disengage the handle:

1. **Push** the ridged pad to unlock, revealing red stripe
2. **Slide** the silver latch towards the left
3. **Pull** the latch outwards, this will push out the handle
4. Once the latch is pulled out, **lift** off the handle.

The port is now ready to accept the VTR or the handle.



X

To lock the VTR or handle into place:

1. Insert the GCH handle, SRW-1 VTR or GDPL BNC box
2. **Push** in the latch
3. **Slide** the latch to the right to lock, red stripe should disappear

X

See [7.7](#) for details about mounting the SRW-1 VTR on to the camera.

4.16 camera top VTR port

The top of the Genesis has a VTR port that is identical to the one on the rear of the camera. The VTR port has 7-pin connector that mates with the SRW-1 or the GDPL BNC box.



Note that the **GCH** black handle depicted here is designed for the top only, not the rear of the camera.

When the VTR is on top, the silver **GHH** carrying handle is inserted into the rear port and screwed into the top of the **GRB** iris rod bracket mounted on the front, as shown in section [7.1](#)

4.17 Camera Rear



The rear of the camera contains a VTR port identical to the port on top. On the right side of the rear are the power switch, tally light switch and LED indicators. There are also 2 reference video BNCs, and a hook for eyeglasses.

TALLY Switch & Red light

Switch up to turn TALLY light on. When TALLY is on, the red light next to switch will turn on during recordings.



MAIN POWER Switch & Green
24V 12V lights

Switch up to turn camera ON.
The camera takes 10-15 seconds
to initialize.

Two green LEDs above indicate
presence of 12V and 24V power
sources.

REF OUT BNC

Two uses:

1. Reference signal output to
connect to GEN LOCK input of
other Genesis cameras.
2. Monochrome output with
menus see **chapter 10**

GEN LOCK BNC

input to synchronize camera to
external reference from another
Genesis or other video source
using a tri-level signal.

*Do not turn off the camera while it is executing a Black Balance
(ABB) as indicated on the LCD panel and in the Viewfinder -- doing
so might change menu settings in unpredictable ways.*

The Genesis can be genlocked in the usual way to a standard external video signal. In addition, the Genesis camera outputs an enhanced tri-level signal with frame rate, shutter angle and phase information that can only be used by another Genesis camera. If you connect the REF OUT from a master Genesis to the GEN LOCK input of a slave Genesis, the slave camera will follow the frame rate, shutter angle and shutter phase of the master camera. These enhanced genlock features will not work if you connect a standard video signal to the GEN LOCK input of the master camera.

Panavision does not recommend connecting external time code generator devices to the GEN LOCK. Instead Panavision recommends plugging the Time Code signal as LTC or into the Audio CH2 of the VTR.

You must remove Lockit and similar devices when shooting variable frame rates. See [chapter 20](#).



The rear VTR connector provides power, video and communication from the Genesis camera to the Sony SRW-1.

4.18 GADC on camera rear

This section will be updated in future

4.19 GDPL BNC BOX on camera rear

The rear VTR port can also be used for the GDPL “BNC box”, which locks into the same spot as the SRW-1 or handle. Similarly, the BNC box can be fitted on to the top VTR port.



See section 10.3 for more information about the BNC box

4.20 camera bottom

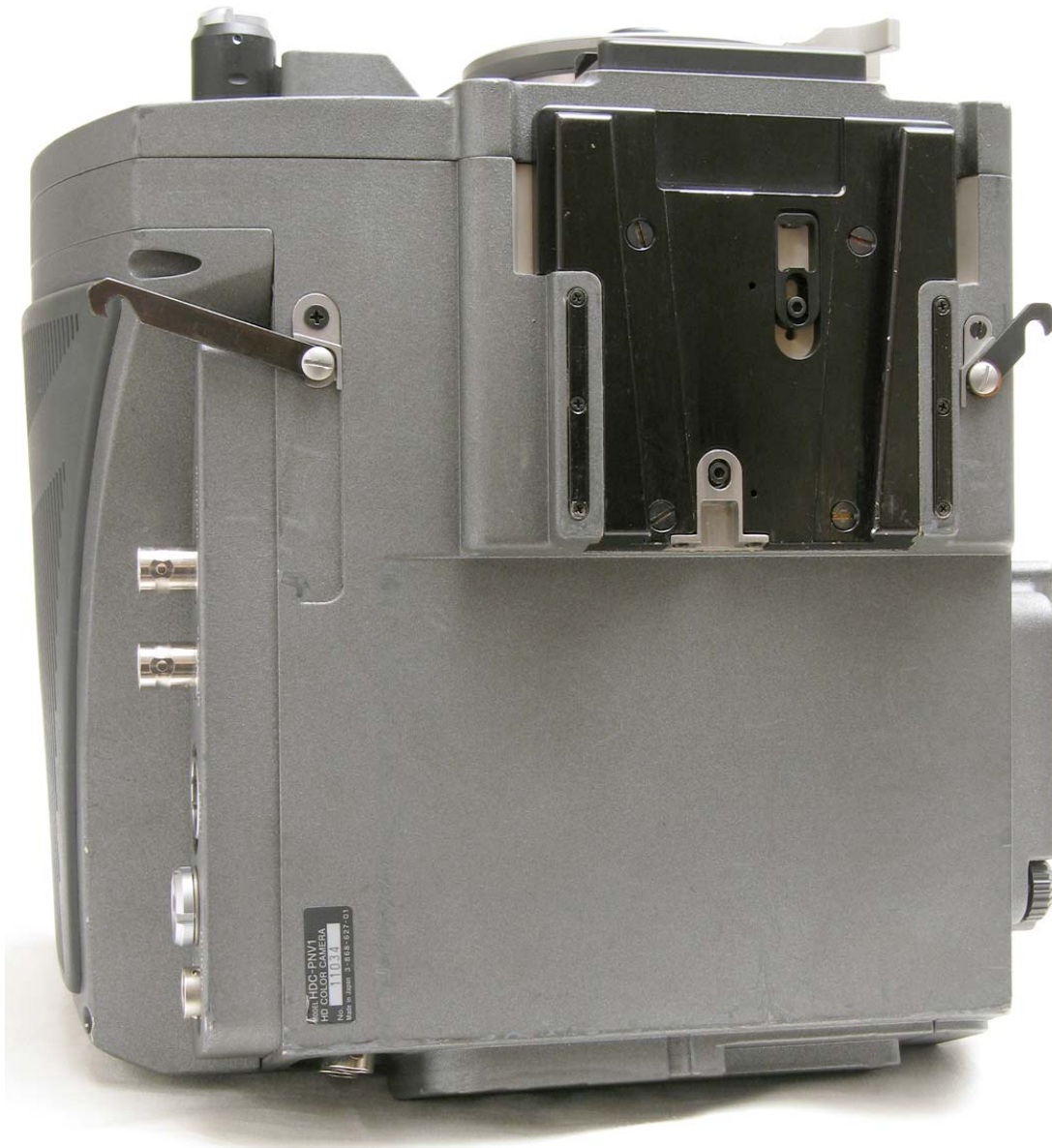

The Genesis bottom has a Panavision dove tail mount and 2 focus hooks that can be swiveled out (when not in use, swivel the focus hooks inwards for storage).

4.21 PCMU camera mount

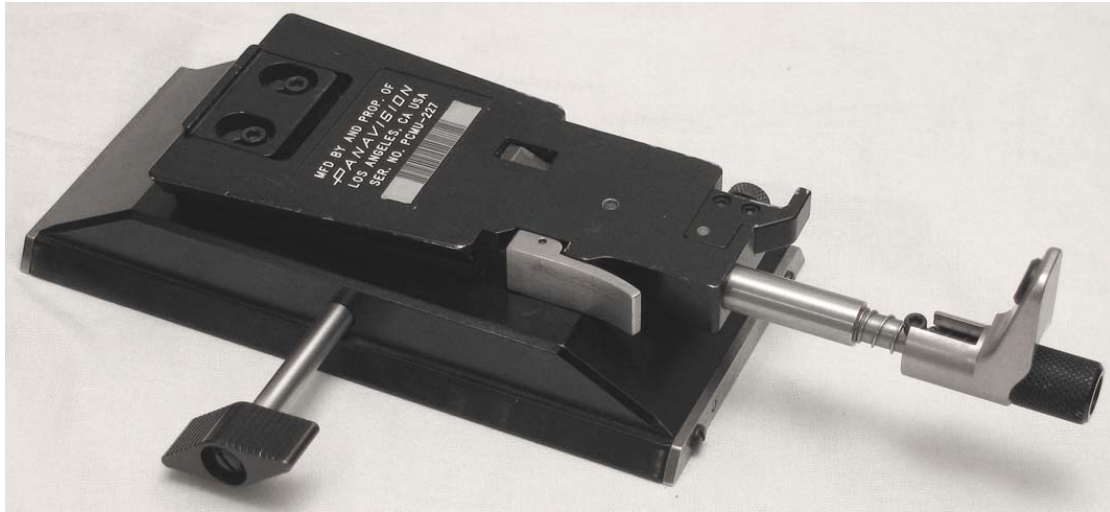

The dove-tail mount on the bottom of the Genesis fits on to the **PCMU** Panavision camera mount and is locked into place by a spring-loaded silver metal tab in the center of the PCMU and a rear lock that is rotated into position and screwed tight.

Putting the Genesis on to the PCMU is similar to mounting a Panaflex camera: slide the dove-tail on the PCMU, it will click in, then swivel the rear tab into a vertical position and turn the black knurled knob to tighten.



5. Genesis Viewfinder

5.1 Assembling the Genesis Viewfinder

5.2 Alternative Viewfinder configurations

5.3 Viewfinder Brightness, Contrast, Peaking

5.4 Other Viewfinder controls

5.5 Separating HDCF and GEP

5.6 Sony HDSF Viewfinder

5.7 Viewfinder Diopter

5.8 Sony Viewfinder Disassembly

5.1 Assembling the Genesis Viewfinder

The Genesis viewfinder is assembled from 4 separate parts, pictured here from left to right:

HDAP (Viewfinder Pivot) with locking ring slides on to camera front bracket

GVFE (Bar)

GVFM (Viewfinder Mount)

GVFE (Genesis Viewfinder Extension) intermediate bar

HDCF (Color Finder) and GEP (Genesis Eyepiece Tube) which usually make up one unit



HDAP

GVFE

GVM

HDCF/GEP



5 Viewfinder locks

The assembled Viewfinder has 4 circular locking knobs, as well as the wide red-labeled LOCK ring, which is used to adjust the angle of the viewfinder assembly to the camera body.



The HDAP slides in to the top silver bracket on the front of the Genesis camera.



Viewfinder cover fitted on (far right)

WARNING

Sunlight shining through the Viewfinder optics will damage the LCD screen. Always cover the Viewfinder when not in use outside. A Viewfinder cover is supplied for this purpose

5.2 Alternative Viewfinder configurations

In special situations, some ACs will swap the GVFM and HDAP in order to move the Viewfinder position forward.

From left to right:

GVFM (Viewfinder Mount) on to camera front bracket

GVFE (Bar)

HDAP (Viewfinder Pivot) with locking ring

GVFE (Genesis Viewfinder Extension) intermediary bar

HDCF (Color Finder) and GEP (Genesis Eyepiece Tube)



GVM

GVFE

HDAP

HDCP/GEP



Alternative assembly to allow Viewfinder to move farther forward



Another alternative is to assemble the Viewfinder without the Bar, by connecting HDAP directly to GVM

5.3 Viewfinder Brightness, Contrast, Peaking

On the outside of the Viewfinder there are 3 knobs and a switch



SEL switch

BRIGHT knob with white dot

Turn to change viewfinder brightness

CONTR knob with white dot

Turn to change viewfinder contrast

PEAKING knob

Turn to change viewfinder apparent sharpness. Peaking adds noise to the signal by augmenting edges.

5.4 Other Viewfinder controls

On the inner side of the Viewfinder there are several controls:



TALLY LOW OFF HIGH switch

Controls level of tally light on upper front of viewfinder. Click into desired position for tally level: dim, off or bright.

ASPECT left click

Click left to toggle frame lines on and off.

The frame line dimensions are defined by Operation Menu O4. See [13.6](#)

DISPLAY right click

Click right to toggle transparent MASK outside frame rectangle on or off in viewfinder.

The MASK size and transparency are defined by Operation Menu O5. See [13.8](#)

ZEBRA MOMENT OFF ON switch

Click left to turn ZEBRA stripes on momentarily for 5-6 seconds. Click right to turn ZEBRA on.

ZEBRAS are diagonal black stripes displayed in the white areas of the image, as a visual indication of signal level. Zebras are rarely used in feature films. The cinematographer might use zebra patterns momentarily as a quick check on highlight exposure. Zebras only appear in the viewfinder. Operation Menu page O6 determines the type of ZEBRAS displayed. See [26.2](#)

B&W push button

Push to go between color and black & white in Viewfinder

MAG push button

Push to turn Viewfinder magnification on and off.

5.5 Separating HDCF and GEP



HDCF (Sony Color Finder) and GEP (Genesis Eyepiece Tube) make up the Viewfinder unit. These 2 pieces are usually together, but can be separated for cleaning, or to show small screen.

To separate Viewfinder

Push in ridged lock underneath and rotate Eyepiece Tube counter clockwise.



5.6 Sony HDSF Viewfinder

There is another version of the viewfinder: the HDSF Sony high definition color viewfinder



As described below, this viewfinder can be disassembled into 3 parts for cleaning, by lining up the 2 red dashes and the 2 red dots:



5.7 Viewfinder Diopter

To the left of the eyecup is the DIOPTER ring with its finger pad

To the left of that is the ridged LOCK ring.

Line up the 2 red dashes to unlock and disassemble diopter element for cleaning.



Diopter
Ring

Lock
Ring

To adjust diopter

To adjust the diopter for your eye turn Diopter Ring until the frame lines or center cross are sharp.



5.8 Sony Viewfinder Disassembly

To remove Viewfinder pivoting assembly for cleaning



Push in ridged lock underneath (pictured here) and **rotate** assembly until two upper red dots line up.



To re-assemble

Line up the red dots and **turn**



6. SRW-1 VTR body tour

6.1 The SRW-1

6.2 VTR configurations: back, top, SRPC

6.3 VTR connectors & switches

6.1 The SRW-1

The Sony SRW-1 is a compact VTR (video tape recorder) that can be connected either on the top or on the back of the Genesis camera, in configurations that evoke a film magazine on a Panaflex camera. The SRW-1 records in the HDCAM SR format, and uses HDCAM SR tapes.



When the Genesis camera and SRW-1 are connected, VTR recording is controlled by the camera, and the power and the video signal are routed automatically to the VTR. The VTR also follows the frame rate and 444/422 settings of the Genesis camera.

6.2 VTR configurations: back, top, SRPC



The on-board VTR can be connected behind the camera...

Some crews prefer this configuration because it helps balance the weight of the lens. This configuration is also often chosen for hand-held.

or on top of the Genesis



Note that each configuration implies a different camera handle.

See [chapter 8](#) for details on connecting VTR.



When separated from the camera, the SRW-1 VTR is connected to the SRPC Sony HD Video Processor box (affectionately known as the “toaster”) that sits below it.

This configuration can be used to record, playback or make “clones” on to another HD CAM SR VTR or down-converted dubs on to a SD (standard definition) VTR.

The SRPC powers the SRW-1 and provides additional inputs and outputs including:

- 12 Volt DC input
- AES/EBU digital audio
- 4: 2: 2 HD SDI
- 4: 4: 4 dual link HD SDI
- down-converted SDI output with option for “burnt-in” Time Code

See [chapter 21](#) for more details

At present, the SRW-1 will not record variable speed correctly when separated from the Genesis camera.

Note that the SRW-5000 VTR does not playback HQ, but only SQ. So you must use either the SRW-1 & SRPC (VTR & Toaster) configuration, or the Sony SRW-5800 VTR, to playback recordings made in HQ mode.

6.3 VTR connectors & switches

The SRW-1 connectors & switches are located at the back when the VTR is on top of the Genesis, and on the bottom when the VTR is mounted on the back of the camera.



CTRL PANEL Lemo connector

Connects the SRW-1 VTR to the SRWC control panel unit (with LCD screen and VTR controls).

POWER ON/OFF Switch

The VTR takes about 10 seconds to initialize after power ON. When VTR is connected to Genesis camera body, the camera POWER switch will control both the camera and VTR. In other words, you must flip 2 switches (Camera and VTR POWER ON) to turn VTR on. However if you turn Camera POWER OFF, both camera and VTR are turned off.

Powering on will activate the VTR fan blowing air out above the connectors. Note that the fan will shut off during recordings, and turn back on when unit is not recording.

Do not turn the VTR off during a recording or videotape playback. Hit STOP first, then turn off.

TC IN BNC

Connects to external Time Code source such as an Ambient Clockit. When connecting to external TC source you usually set the **Regen Source** to **External LTC**. This item is found by going to : VTR Menu -> TC -> REGEN SRC. See **18.3**

TC OUT BNC

Provides time code output, typically used to feed a recording machine when doing dubs.

EARPHONE Female Stereo Mini

Audio output from VTR connected to Headset or to Sound Recordist. *The Earphone output is controlled by the **Phone Select** page found by going to : VTR Menu -> AUDIO -> PHONE SEL. See **19.8***

LEVEL knob with center detent

Controls EARPHONE audio level.

AUDIO INPUT CH1 Female XLR

Connects to incoming analog audio for channel 1.

Channel 1 is often used as a “scratch track” and fed from the Sound Department via cable or wireless unit.

AUDIO INPUT CH2 Female XLR

Connects to incoming analog audio.

Channel 2 is often used for secondary LTC time code signal fed from the Sound Department via cable or wireless unit.

LINE MIC MIC+48VON 3-position Slider Switches

Each of the two switches selects the type of audio signal connected to the XLR below it (**CH1** or **CH2**).

LINE – is for line level signals, typically from Sound Department

MIC – is for microphone level signals, or in rare cases, an ordinary microphone

MIC+48VON – is for “phantom-powered” microphones that require a 48 volt power supply.

Consult the Sound department to check whether the audio and or LTC (time code) signals are microphone or line level. An incorrect setting will give you a distorted audio or LTC signal.

7. VTR SRWC panel

7.1 VTR SRWC panel – separating

7.2 VTR SRWC panel – HOME screen

7.3 FUNC + HOME – changing bottom of HOME display

7.4 VTR SRWC panel – Controls

7.5 Standby ON or OFF

7.6 VTR SRWC panel – FUNC controls

7.7 Turning VTR off to save power, and lower noise



The Sony SRWC is a control panel with LCD screen that is plugged into the main SRW-1 body via a short cable with a Lemo connector:

- On the left is a column of 5 black rectangular buttons to select different menus
- In the upper-right corner are 2 controls for menu navigation: a thumbwheel and a push button
- On the lower right are 8 colored buttons for VTR control
- Above those are 2 switches for key inhibition and LCD lighting and a big circular adjustment control for setting levels.

IMPORTANT

When the SRW1 is mounted on the Genesis, any setting you enter on the camera (like frame rate and 444/422 selection) will automatically over-ride settings entered in the VTR.

So when you are working with the VTR mounted on the Genesis, you will only need to access VTR controls to do the settings that are not available in the Genesis. This usually means:

EJECT the tape housing

Changing Time Code hour after tape change (See 18.2)

Set-up of Audio Level (See 19.4)

Of course, it's still useful to understand the SRWC panel indicators

7.1 VTR SRWC panel - separating

The SRWC panel is locked on to the side of the SRW-1 VTR with a V-shaped bracket.

To separate the SRWC from the VTR



Push the right-hand black spring-loaded lever towards the right.



X

Next to the black lever, is an **EJECT** button that can be used when the panel is unavailable. This EJECT button is hidden when the SRWC panel is locked on.

Some Camera Assistants will position the SRWC on the left side of camera using some Velcro and the 18 inch cable (CS-SRWM) in the case.

7.2 VTR SRWC panel – HOME screen

The LCD **HOME** menu screen has 4 horizontal areas. The bottom 3 bands contain a lot of useful information for the Camera Assistant.

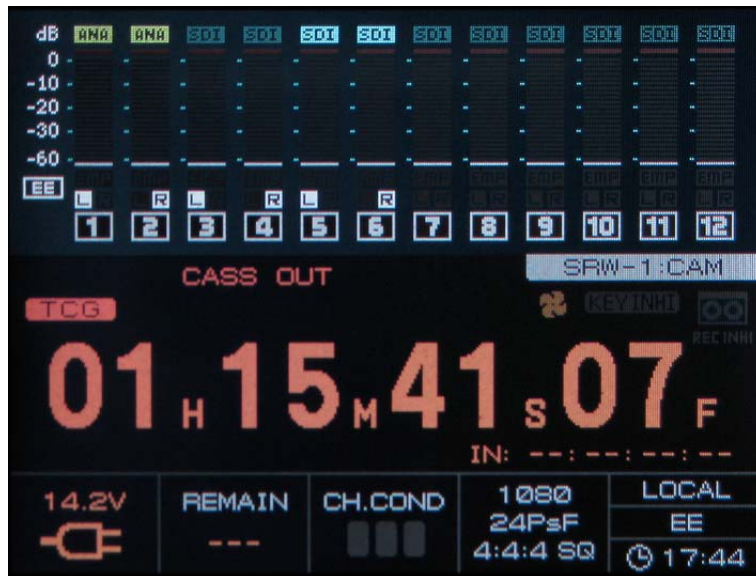

Audio levels
for 12 channels

Status, warnings

Time data

Voltage and
Other Info

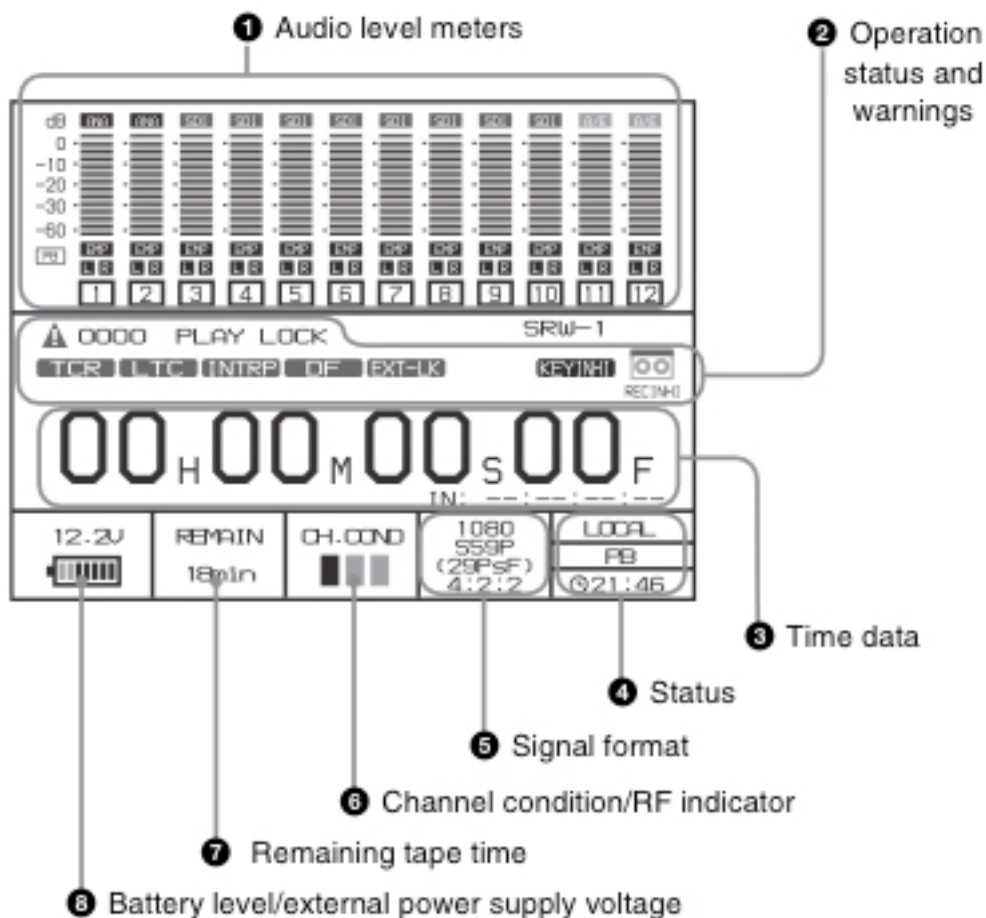

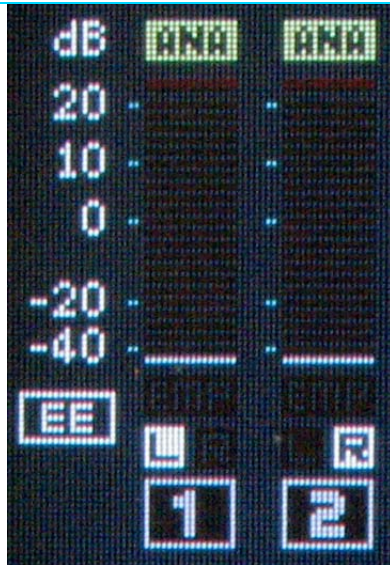

1 Audio level meters

Graphic display of audio level of the 12 audio tracks during recording, E to E or playback. (E to E is the record signal in stop or pause mode).

Typically, only the first 2 tracks are used to record feeds supplied by the sound department:

- 1 for **ANA**log scratch audio
- 2 for **ANA**log time code

2 Operation status and warnings

Status and warnings that light up in this area include:

Yellow ! triangle with a four digit number indicates a warning.

Please go to Chapter 33 VTR warning and error messages for more details.



SRW-1 : CAM (white rectangle) – Indicates that SRW-1 is mounted on Genesis and communicating with the Camera.

CASS OUT – No videocassette in the VTR

The Blue rectangular cassette Icon indicates a cassette in the VTR

PLAY/REC LOCK – Indicates playback or recording locked to the reference signal.

TCR/TCG/UBR/UBG/CT (red rectangle) – The type of time data displayed. Typically will be **TCG** during recording

LTC/VITC – Whether time code displayed is LTC (longitudinal) or VITC (vertical interval).

INTRP – Indicates time code is interpolated because it could not be read accurately

DF/NDF – Whether the time code is in Drop Frame or Non-Drop Frame mode

EXT-LK – Indicates that valid Time Code is being fed to the VTR TC IN.

EXT-LK does NOT indicate Gen Lock to an external signal.

Flashing **Yellow Fan icon** indicates that the FAN is in REC LOW or REC OFF mode. REC OFF is the Panavision recommended setting. See **27.6** DIAGNOSIS>OTHER>FAN VTR menu for more details

KEY INHI – The KEY INHI switch on the panel is on (see **7.3**)

REC INHI – The cassette is record inhibited: the small tab on the bottom has been depressed.

3 Time data

Displays time data in **H**ours **M**inutes **S**econds **F**rames

Typically this will be the time code

Below in smaller numbers is a display of **IN**point time data, if one has been defined.

4 Status 3 row display

Top: LOCAL/REMOTE.

Middle: **EE/PB**.

Bottom: clock with time of day



- Top row is usually LOCAL unless you are controlling VTR remotely through SRPC REMOTE IN. (See **27.5** SYSTEM VTR menu)

- Middle row is usually EE (Electronic to Electronic), unless you are using VTR for playback only under remote control

See **27.5** SYSTEM>POWER>MODE VTR menu

- To set the clock see **18.3** TC>OTHERS(MAIN)>RT VTR menu

5 Format 3 or 4 row display

Top: 1080/720

Middle: Target Playback speed

Bottom: 444/422 SQ/HQ



- Top row is usually 1080, unless you are recording 720P
- Middle row is the Target Playback speed in frames per second. Unless you are in variable speed, this is also the recording speed. During variable speed recording this line will split into two lines: the recording speed and target playback speeds.

- Bottom row is usually 4: 4: 4 SQ, unless you are required to go to 4: 2: 2 because you are recording between 30 and 50 fps speed.

See *chapter 20 About variable speed* for more information about format display. And *21.9* re HQ/SQ.

6 Channel Indicator/RF 2 or 3 column display

During playback

CH.COND

green yellow or red rectangle



During recording

RF

green or *red* rectangle

- CH COND color During playback:
 - green is usual, indicates good signal
 - yellow indicates degraded signal, but playback still possible
 - red indicates a problem, if it persists clean the heads with a cleaning cassette.



- RF color during recording

green is usual, indicates good signal

red indicates a recording problem

If you get a red RF light during recording, stop recording and check playback. If problem continues eject video cassette and put in cleaning tape.

If problem persists after cleaning, contact your Panavision representative.

7 REMAIN 2 line display



Display of minutes remaining on cassette

Indicates TOP at beginning and END at end

Time display will flash when tape is within 3 minutes of end.

8 Voltage and Battery Level/Power Supply

- When using a VTR battery indicates power left: 7 segments indicate full charge

When battery needs changing:

NEAR END indicator appears

Display flashes with increasing frequency

END indicator appears, along with warning

Note that the plug icon merely indicates the settings chosen in the SYSTEM>BATTERY>DCIN TYPE VTR menu, See 18.3

- With plug icon, the top line is the voltage used by the system, which is lower than the actual input voltage

7.3 FUNC + HOME – changing bottom of HOME display

Keep the FUNC button down and push HOME to merge the bottom band of the HOME screen and cycle through 2 new display modes:

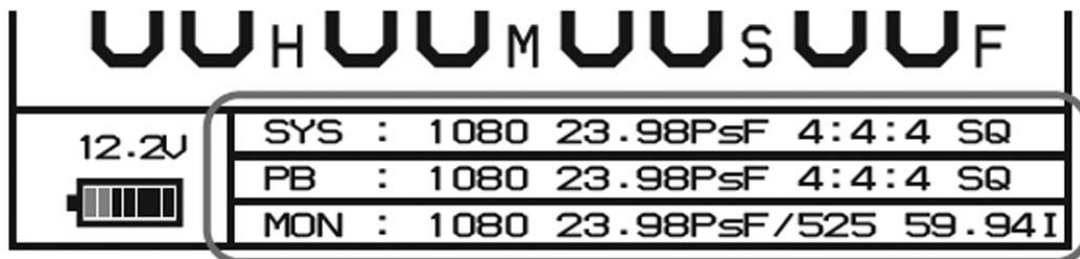

SELECT FPS information

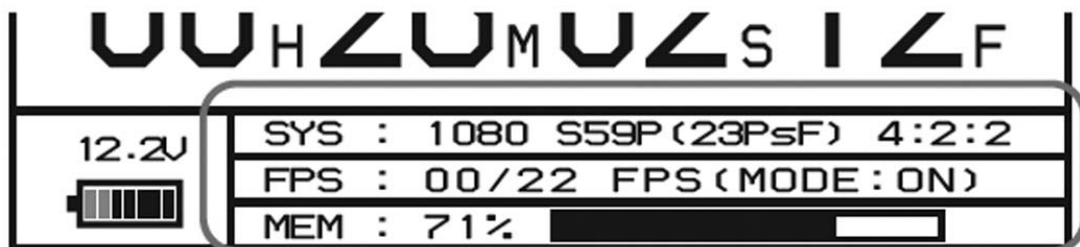

Signal format

The **SELECT FPS** Information mode shows you

SYS format for recording

the target **PB** format,

the optional **MON**itor output for downconversion, etc.

See [14.8](#) for more information on the **SELECT FPS** menu

The **Signal format** display mode gives you

SYS format for variable speed recording (with target PlayBack speed in parentheses),

FPS variable speed setting,

MEMory cache status in variable speed recording. See [20.14](#)

See [21.10](#) for **Signal Format** menu

7.4 VTR SRWC panel - Controls



HOME

Push this to return to the main screen, with audio levels, status and warning messages, time code and other information

TC

Push to go to Time Code menu screen

VIDEO

Push to go to Video menu screen. The video menu is usually empty unless the SRW-1 is connected to the SRPC toaster

AUDIO

Push to go to Audio menu screen

SYSTEM

Push to go to System menu screen

SELECT/ENTER Thumbwheel

Rotate to select, that is, to change menu item or setting

Push to enter, that is, to confirm menu setting

BACK push button

Push to return to previous screen



To return to main screen push HOME

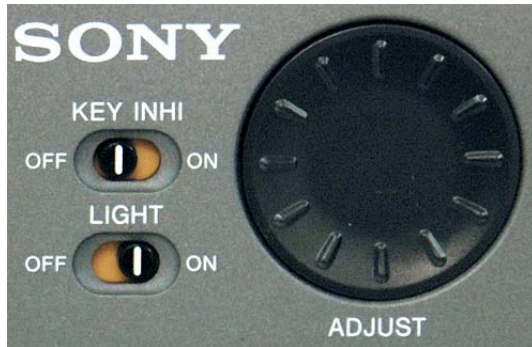

ADJUST finger wheel

Rotate to adjust menu setting, usually used for audio level.

KEY INHI switch

Turn ON to “inhibit” keys, that is, make them inactive. The keys that are inhibited are chosen in the SYSTEM -> KEY INHI menu. *Panavision recommends turning KEY INHI ON unless you need to access a key.*

LIGHT switch

Turn ON to keep LCD screen backlit. Turn OFF if shooting in a situation where you don't want any ambient light.



Panavision recommends avoiding the STOP, PLAY, REW or F FWD keys on the set, to avoid mis-cueing the tape, accidental erasure of shot footage and time code gaps.

If you have played or shuttled the tape, or turned the VTR off, use the REC REVIEW assignable switch on the Genesis body to ensure continuous time code. See [4.2](#)

EJECT button

Push to open cassette door, allowing you to take videocassette in or out of the SRW-1. Eject is inactive during recording.

STOP button

Push to stop playback or recording.

If in Standby off mode, press to put SRW-1 in Standby on mode.

If in Standby on mode, press to reset still timer. (see 7.4)

It is preferable to use PAUSE to cut a recording. If you push STOP during a recording, you may have discontinuous time code. If you have pushed STOP, push REC REVIEW assignable switch (see 4.2) on the camera to cue tape at end of last recording.

PLAY button with indicator light

Push to playback tape, the indicator light will confirm playback.

Or push simultaneously with **REC** button to start recording.

REC button with indicator light

Push simultaneously with **PLAY** button to start recording, the indicator light will confirm recording with a solid red.

When in pause or stop, push to initiate "E to E" ("electronic to electronic") mode.

In E to E mode the HD SDI OUT will display the input that would be recorded without actually recording.

*When the VTR is on the camera, the Genesis **record** button is used to start and stop SRW-1 recording. See also 6.2*

REW button with indicator light

Push to rewind tape

F FWD button with indicator light

Push to fast forward tape

PAUSE button and indicator light

Push once to start or to pause recording or playback.

When VTR is in pause, the indicator light flashes.

Use PAUSE and not STOP to cut a recording at the end of a take.

This will ensure continuous time code.



SRWC panel during a recording: note green RF light on LCD and Red lights in PLAY and REC buttons

7.5 Standby ON or OFF

There are 2 possible RECOrd PAUSE modes:

1. STANDBY ON

The video rotary head drum is spinning, which means that recording can start quickly, but there can be wear and tear on tape when PAUSEd for a long time. In Record STANDBY ON mode you cannot change settings in the VTR menus.

Standby turns off automatically after a time period defined in the VTR menu SYSTEM -> SERVO -> Stby Off (See 27.5)

You can turn Standby back ON by pushing STOP

2. STANDBY OFF

The video rotary heads are not spinning, which makes for a slower record start up, but less wear and tear on the tape.

You can turn Standby OFF by holding down FUNC key and pushing STOP.

7.6 VTR SRWC panel – FUNC controls

FUNC yellow button

Multi-purpose control. Keep this button pushed down and then press another button to get one of the functions detailed below:



FUNC + STOP

Puts SRW-1 in STANDBY OFF mode

The VTR must be in Standby Off before you can change Recording settings. Push FUNC + STOP if you get an error message stating "Can't change while Standby On" See [20.11](#)

FUNC + PLAY

When recording is paused, this is the equivalent of **REC REVIEW** assignable switch on the Genesis (See [4.2](#)). This function is defined by the SYSTEM -> SERVO -> REC REVIEW menu

The Record Review function automatically rewinds the tape and plays back the last 10 seconds (or 3 seconds) of the last take, and then stops, cueing the tape for the next recording.

When tape is stopped, push to cue tape at the end of last recording.

FUNC + REC

Temporarily memorizes the current position as the Mark In point for future cueing.

FUNC + REW

Push repeatedly to cycle through 3 different rewind speeds:

x2 -> x5 -> x8 ->2

FUNC + F FWD

Push repeatedly to cycle through 3 different fast forward speeds:

x2 -> x5 -> x8 ->2

FUNC + PAUSE

Push to cue tape to Mark In point defined previously by FUNC + REC

This In point can also be defined by SYSTEM -> EDIT menu.

7.7 Turning VTR off to save power, and lower noise

When you do not expect to record immediately, keeping the SRW-1 VTR off saves battery life, and is less noisy. After you turn the VTR back on, use the REC REVIEW assignable switch on the Genesis body to ensure continuous time code. See [4.2](#)

8. Mounting the SRW-1 & loading tape

8.1 To mount SRW-1 to rear port of Genesis camera

8.2 To remove the VTR from rear port of Genesis

8.3 Loading a video cassette

8.4 Tape precautions

8.5 Using Record Review

8.6 Ejecting the cassette

8.7 Changing Time Code Hour with each new tape

8.8 Different tapes for different speeds

8.1 To attach SRW-1 to the rear port of Genesis camera

1. Ensure that Genesis is attached to a firm support

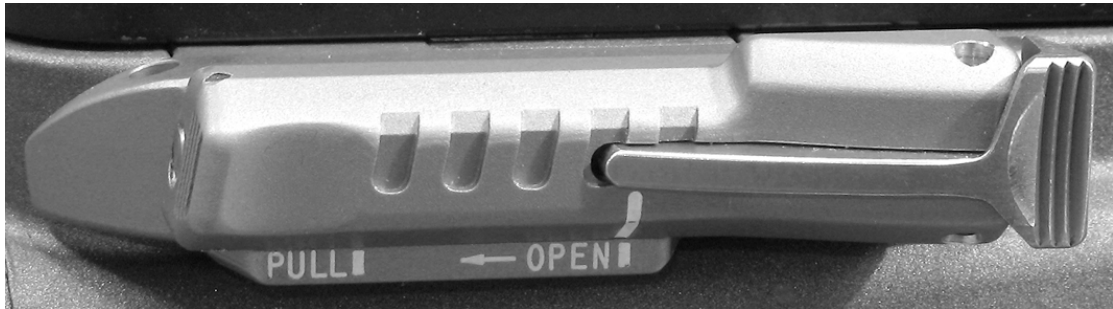

2. Unlock silver VTR port latch by **pushing down** on the ridged pad, revealing a red stripe, and **slide** silver latch upwards to unlocked position



3. **Pull** silver latch outwards away from camera body
4. **Orient** VTR with connector facing down



->

5. Use both hands to carry VTR and **place** it carefully into VTR port



6. **Push** VTR downwards firmly, the silver latch should move in towards the camera body.

->

7. Once VTR is securely in place, **push** silver latch downwards to lock. Once locked the red stripe should no longer be visible on the silver latch.

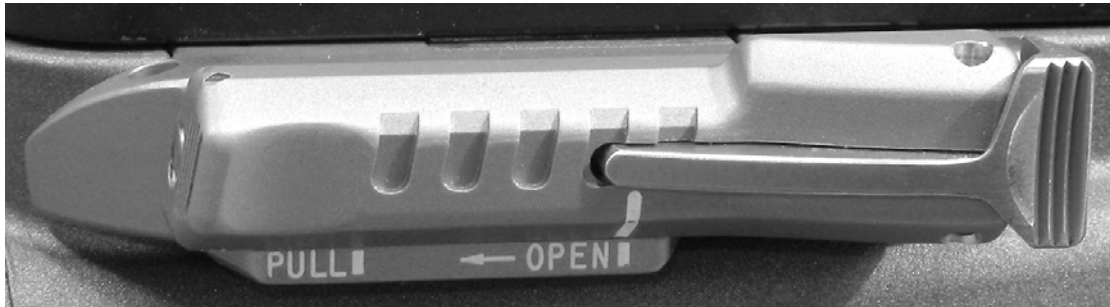

8.2 To remove the VTR from rear port of Genesis camera:

1. Unlock silver VTR port latch by **pushing down** on the ridged pad, revealing a red stripe, and **slide** silver latch upwards to unlocked position

2. **Push** silver latch outwards and downwards, this starts to push out VTR



4. Hold VTR with both hands, and **pull** the unit away from camera, bottom first.



5. **Push** the silver latch towards camera body, and **slide** it down to its locked position. Once locked the red stripe should no longer be visible on the silver latch.

The same procedure can be used to dismount the VTR from the top port

8.3 Loading a video cassette

You cannot load a video cassette unless the SRW-1 is powered ON.
See [Chapter 9](#) for more details about powering camera and VTR.

To insert a cassette:

1. Push EJECT to open tape door
2. Insert cassette as depicted, with blue edge facing upwards (or towards front with VTR on top), until it's all the way in.



3. Close tape door.

X

The blue-striped HDCAM SR tape is the only tape that works in Genesis. HDCAM tapes used in the F900 are similar in size but will not thread in the SRW-1.

8.4 Tape precautions

HDCAM SR tape is very robust. Nonetheless, normal precautions should be taken for storage in the field: avoid extremes of temperature and excessive moisture. HDCAM tape is insensitive to airport X-rays.

8.5 Using Record Review

By using the “Record Review” assignable button, you can safely play back the last three or ten seconds of your recording to check that the scene was recorded properly. See [4.2](#)

Panavision does not recommend playback without using RECOrd REView on the set, because there is a danger of recording over your “original negative” or of creating a time code discontinuity.

8.6 Ejecting the cassette

The cassette should be ejected whenever the camera will not be used for an extended period, such as when breaking for lunch or for the day. If you insert the same tape later, use the Record Review function to cue to the end of the last take.

8.7 Changing Time Code Hour with each new tape

Most productions will change the time code hour with every tape. For example the third tape of the day will start at 3:00:00:00 (3 hours 0 minutes 0 seconds 0 frames) and the following tape will start at 4 hours. See section [18.2](#) to change PRESET time code.

8.8 Different tapes for different speeds

Panavision recommends using different tapes for each different speed used. See [chapter 20](#) for more information about variable speeds.

9. Powering the Genesis

9.1 Genesis Power overview

9.2 Current Consumption

9.3 connectors for 14NM33 Battery

9.4 Using the 14NM33 battery

9.5 Battery Fuses

9.6 The GPC Battery Charger

9.7 To charge a battery

9.8 Charger LED indications

9.9 Using the GPS Genesis Power Supply

9.1 Genesis Power overview

The Genesis camera body runs on 14.4 Volts, but it has 24 Volt outputs on its front to power Panavision film accessories, like zoom motors, which are traditionally 24 Volt.

There are 3 ways to power the Genesis:

1. The Panavision **14NM33** battery, a custom high-capacity unit designed specially for the Genesis. The output goes from 11.5 to 16.5 V
2. The Panavision **GPS** power supply that runs on AC
3. The Panavision **14NM15** battery belt

The Power Supply and Battery can feed 12 and 24 Volts simultaneously in the same multi-pin connector or separately.



14NM33 Genesis Battery
with black foam-covered
handle



GPS Genesis Power Supply

Panavision recommends that you do not use non-Panavision batteries or power cables, as you may damage the camera.

9.2 Current Consumption

Here are some general indications of power consumption, which will vary with ambient temperature:

Camera at 30 fps or less: 5 Amps

Camera at 30 to 50 fps: 7.5 Amps

Sony Viewfinder: 0.5 Amps

SRW-1: VTR 5 Amps

Astro on-board monitor: 1.1 Amps

When you do not expect to record for a while, keeping the SRW-1 VTR off saves battery life, and is less noisy. When you power back on, use REC REVIEW button to avoid a time code holes (see 4.2).

9.3 connectors for 14NM33 Battery

The Genesis battery has 4 connectors on top:

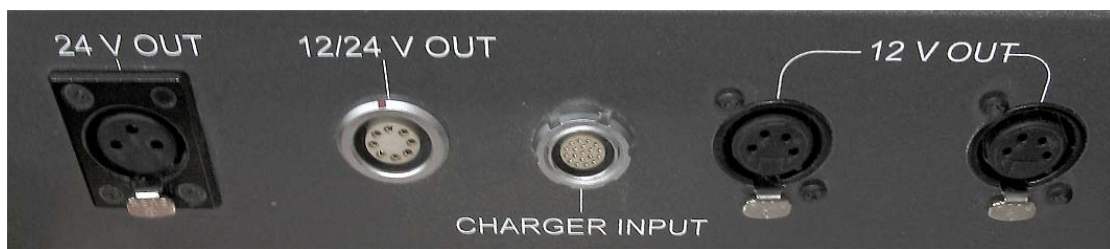

24V OUT female XLR

Use to power Panavision film accessories like zoom motors.

12/24V OUT female multi-pin connector

Use to power Genesis camera, with a male to female power cable.

CHARGER INPUT female multi-pin connector

Connect to the GBC Genesis battery charger to charge battery, using a male to male charging cable.

12V OUT 2 female 4 pin

Use to Power 12 Volt accessories

There is an additional 12 V plug on the side of the battery

9.4 Using the 14NM33 battery

Take a Genesis power cable and plug into the male **POWER** connector on the camera, then plug the other end into the female **12/24V OUT** connector on the battery.

Both connectors have a slot at the 12 o'clock position with a red-mark, use the slots to orient the plugs correctly.

Battery cables are limited to a maximum of 30 feet (9 meters), because the camera draws a significant amount of power.



An unlabeled 5-pin female XLR on the side of the battery is for connecting 2 batteries at once to the Genesis with a **CBLE-GPP** male to male 5-pin XLR cable

A **RealTime** battery display on the battery top graphically indicates the amount of time left under normal circumstances.

Big numbers indicate hours, quarters of an hour are displayed in a pie chart format. You can expect between 2 and 3 hours of battery life with a normal package, including an on-board monitor. Most crews take out 3-4 batteries per camera.

3 examples of time left indicated on **RealTime** battery display:



2 hours 15 minutes



45 minutes



Empty battery

Battery duration will change in extreme heat or cold.

When temperatures drop below zero, you should expect reduced performance from the batteries.

When the temperature rises above 110 degrees, batteries should be changed when their output nears 13 volts.

On the set, Panavision recommends getting in the habit of "battery first". That is, when moving the Genesis, plug in the battery first and power up immediately, so that you can quickly see an image in the viewfinder.

9.5 Battery Fuses



The Genesis battery has 2 fuses along its bottom:

6.25 Amp

20 Amp

Battery fuses rarely blow, when they do it is an indication of a problem. If the battery fuse blows, contact your Panavision representative before changing the fuse.

Each fuse can be changed by unscrewing slotted grey fuse holder and slipping a new fuse in.

9.6 The GPC Battery Charger

The GPC Genesis battery charger is a light-weight box with a single female multi-pin connector labeled CHARGER OUTPUT



9.7 To charge a battery, take a male to male charging cable and plug one end into the CHARGER OUTPUT on the GPC and the other in the identical CHARGER INPUT connector on the battery.



Use the indent at the 9 o'clock position to guide the charging cable.

Note that the charging cable is not the same as the power cable used to connect the battery to the camera.



9.8 Charger LED indications

The GPC charger has 9 LEDs on its top

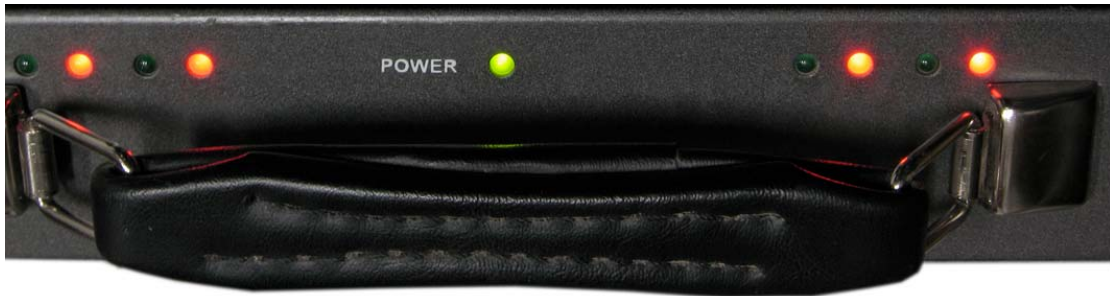

The central Green POWER LED indicates that the unit is on. On each side, there are two pairs of Green and Red LEDs (8 in all) that indicate the charge status of the four cells in the Genesis 14NM33 battery.

When you power the GPC charger, you should see the following self-test LED sequence:

1. Each LED turns ON from left to right
2. All the LEDs flash

If you don't see this sequence, it may indicate a faulty GPC unit. Contact your Panavision representative.

When you connect a battery to the GPC charger, you should see the following LED sequence:

1. All the LEDs flash
2. All 4 red LEDs slowly flash, indicating the unit is charging the battery
3. When the battery is 80% charged, the LEDs will flash green. In a pinch, the battery can be used although it is not fully charged.
4. When all the LEDs are a solid green, the battery is fully charged.

Genesis batteries normally take 6-7 hours to recharge.

9.9 Using the GPS Genesis Power Supply

The Genesis Power Supply is itself powered by 115/230 Volt AC at 50/60 Hertz.



The **GPS** box has 4 outputs and 2 LEDs:

12 V OUT – 2 female 4-pin XLRs

To power non-Panavision accessories. Typically used to power Astro on-board monitor.

12/24 V OUT – female multi-pin Lemo

Use to power Genesis camera, via a male to female power cable plugged into the male **POWER** connector on the camera right side. The Genesis power cable has a red dot to indicate the 12 o'clock position. Use only Panavision-supplied cable.

24 V OUT – female 3-pin XLR

To power Panavision accessories, such as zoom motors,

12 V and **24 V** blue LEDs

Light up to indicate unit is on and delivering 12 and 24 Volts

10. Video monitoring

10.1 The Genesis has 4 video output connectors

10.2 The GADC box for down-conversion & dual-link HD-SDI

10.3 The GDPL BNC box for dual-link HD-SDI

10.4 video connections on set

10.5 Astro on-board HDAM monitor

10.6 The Astro buttons on the front

10.7 Connectors on the back of the Astro

10.8 To adjust your monitor using color bars

10.9 To adjust Chroma and Hue using Blue Only

10.1 The Genesis has 4 video output connectors:



1 VF1 multipin on front upper right – Viewfinder 1 is the main viewfinder output

2 VF2 multipin on front left – optional Viewfinder 2 (with characters always on) which is rarely used

3 MONITOR BNC on right side – main output of camera, it is controlled by **MONI OUT** on Operation menu 11. Sometimes labeled HDSDI

4 REF OUT BNC on back – A luminance-only (black and white) version of the VF2 output that can be plugged into the “Y” input of a monitor to consult the menus discreetly. As with the VF2 signal, the characters are always on.

10.2 The GADC box for down-conversion & dual-link HD-SDI

photo and description to be added

10.3 The GDPL BNC box for dual-link HD-SDI

Note that Dual-link HD-SDI 4:4:4 output is also available by plugging an optional **GDPL** (“BNC BOX”) adaptor in the unused VTR port. (See [chapter 20](#) for more details).



Panavision recommends that the BNC video output be monitored.

The GDPL BNC box supports a maximum cable length of 75 feet when using L5CFB cable. When using L2.5CFB cable the maximum length is 30 feet.

Panavision recommends that you do not use a longer cable run unless you have a re-clocking DA (distribution amplifier).

10.4 video connections on set

The main video output from the Genesis is labeled **MONITOR** (or **HDSDI**). It is usually fed to the Astro **SDI IN CH A**, and the Astro **MONITOR OUT** feeds the other HD monitors on the set.

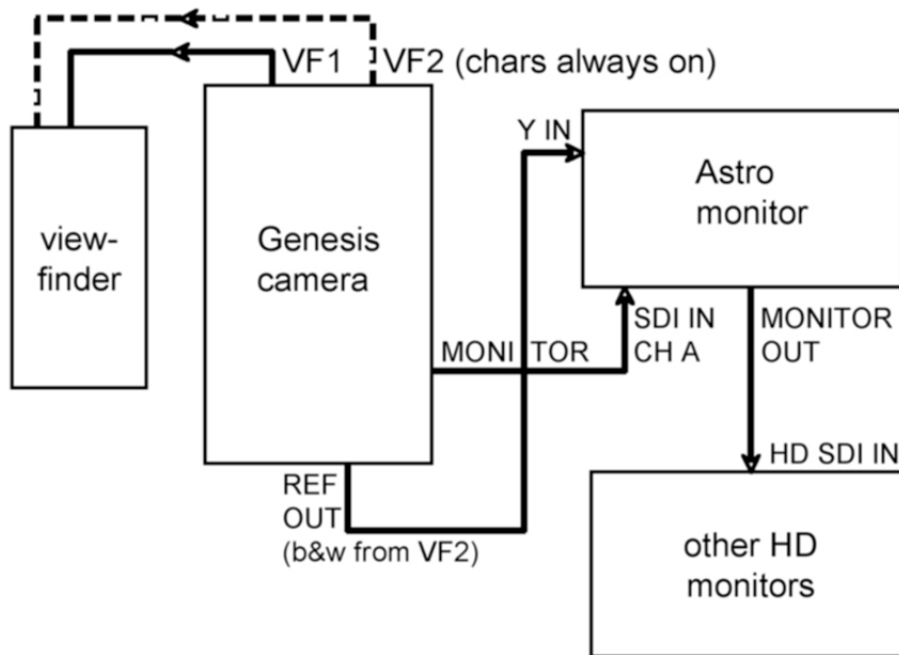

The **REF OUT** from the Genesis can be connected to the **Y IN** of the Astro. That way, the camera assistant can check out the menus (by keeping the Astro **INPUT** button pushed down for a second) without disturbing the image seen by the operator in Viewfinder1 or by the DP and director on the other HD monitors.

The second viewfinder output is rarely used.



*Click down on the Genesis assignable switch **2** to turn the characters on/off on the **MONITOR** video output.*

See [4.3](#)

10.5 Astro on-board HDAM monitor

The Genesis comes with an **HDAM**, an on-board Astro DM 3005-A HD monitor with a 6.3 inch LCD screen.



Controls on the bottom right of the Astro front:

Adjustment dial

Turn left or right to select and adjust settings

LOCK OFF/ON switch

Turning ON simultaneously locks and saves current settings. A yellow LED indicates LOCK status

POWER switch

Green LED indicates power on



When the Astro is powered on it goes to the settings last saved with **LOCK**.

10.6 The Astro buttons on the front:



INPUT – Push to cycle between SDI A or SDI B inputs.

Pressing the button for 1 second will switch to the analog inputs (Y Pb Pr)

BRIGHT – Push to change brightness using adjustment dial

MAG – Push to turn magnification on or off

CONTRAST – Push to change contrast using adjustment dial

MONO – Push to go to black and white

CHROMA – Push to adjust chroma with dial

MARKER – Push to turn frame lines on/off

PB – Push to adjust blue component

MENU – Push to turn menu on or off

PR – Push to adjust red component

The Astro **HDAM** has 2 display modes: RGB or YPbPr. Many assistants use the YPbPr because you can adjust **CONTRAST** and **CHROMA** for the many different viewing environments of a film set.

Most assistants use the Genesis frame lines, and therefore leave the Astro **MARKER** off.

10.7 Connectors on the back of the Astro



SDI IN CH A BNC

CHannel A HD-SDI or SDI input.

Typically connected to Genesis MONITOR output

SDI IN CH B BNC

Channel B can be used for a second HD-SDI signal, or an SDI signal.

Y IN BNC

Analog luminance signal input.

Sometimes connected to Genesis REF OUT

PB IN BNC

Analog Pb signal input

PR IN BNC

Analog Pb signal input

MONITOR OUT BNC

Outputs A or B SDI signal selected on front panel. When Analog input is selected, outputs CH A. Typically connected to HD monitor on the set

INPUT 75/HIGH 3 micro switches

75 ohm termination of Y Pb Pr inputs

TALLY multipin

Control for green and red tallies on front of Astro. Not often used.

DC IN 12V male 4-pin XLR

Typically connected to the 12V output at the front of the Genesis

*As noted in 10.4, some assistants connect the analog **Y IN** of the Astro to the **REF OUT** of the Genesis so that they can see a menu without displaying it on the Viewfinder1 or on the main **MONITOR** output that goes out to the set.*

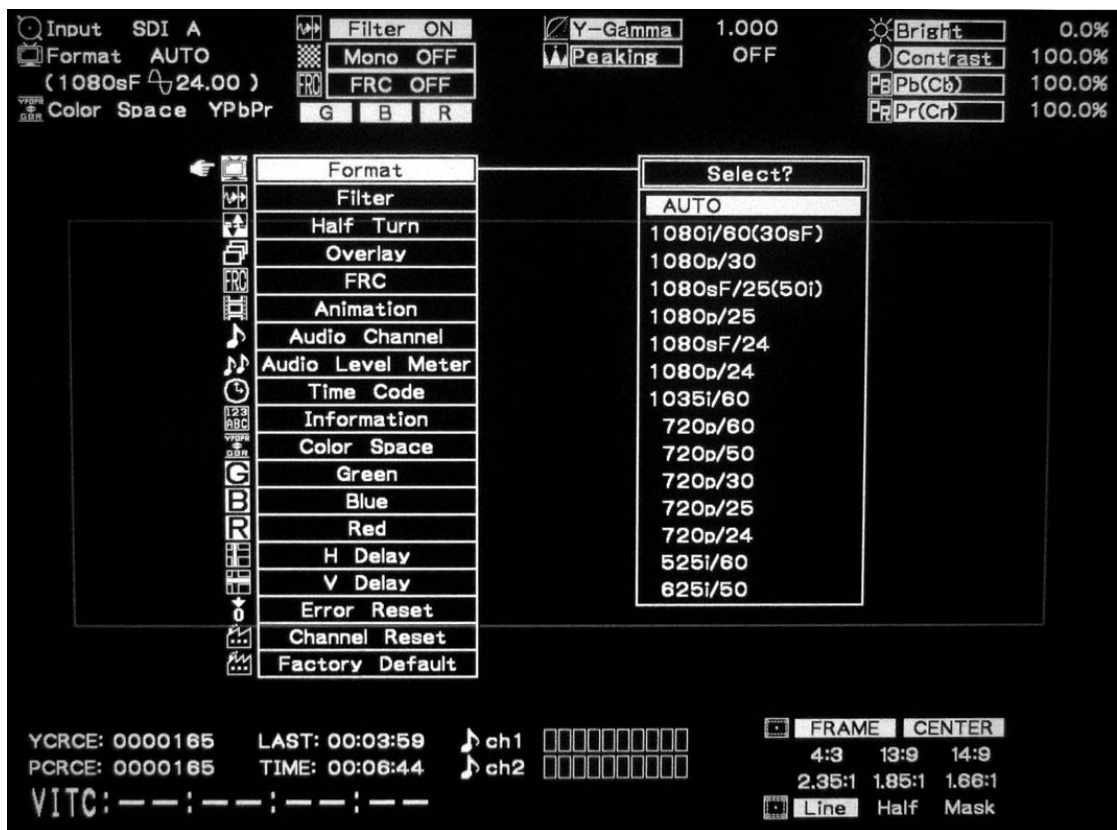

The Astro menu displayed between the 8 rows (4 on top and 4 on bottom) of the information screen

Turn and push the **adjustment dial** to navigate the menu.

Many camera assistants adjust **Information OFF**, to keep a clean screen.

Note that a battery can be fitted on to the back of the Astro, for example to use it as a portable director's monitor.

For a detailed explanation of the complex range of the Astro's capabilities, you can download the 43-page Astro manual for the DM 3005-A in PDF format at:

<http://www.astro-systems-downloads.com>

Rough adjustment of the monitor using color bars

Once you have an image on the Astro or other HD monitors, you should quickly check color bars. If you have a calibrated monitor, leave it in its default settings. If you don't:

10.8 To adjust your monitor using color bars

1. **Turn on** COLOR BARS using the Genesis LCD menu. See 11.4 for details
2. SMPTE color bars have 3 narrow black columns at the bottom of the image called the PLUGE bars. **Adjust** the Brightness control on your monitor so that Pluge bar 1 and 2 are indistinguishable, but you can still see bar 3.

SMPTE color bars

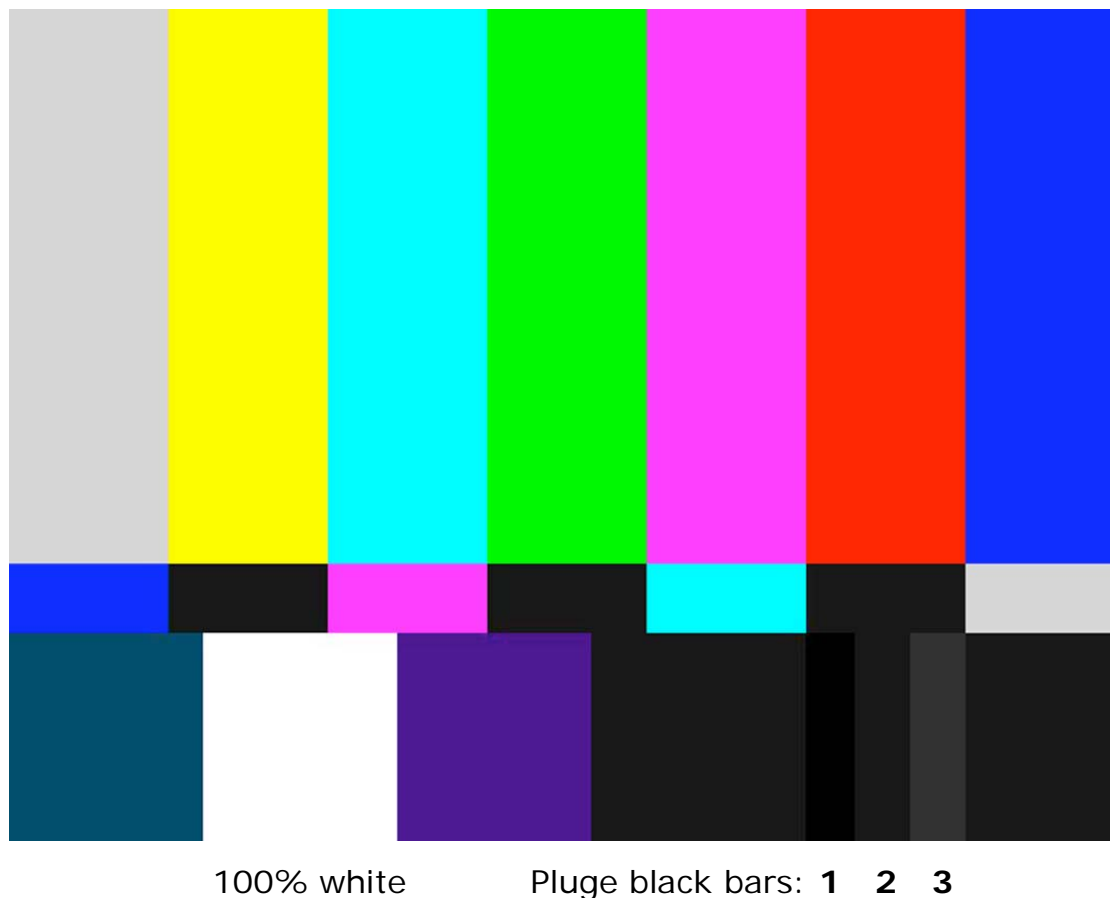



3. **Adjust** the Contrast on your monitor so that the bottom White bar (100%) does not “bloom” (bleed into the surrounding areas). You may have to then re-adjust brightness.

These two settings should establish a roughly accurate image.



Some monitors also have a “Blue Only” control. You can use this to refine Chroma (or color) or Hue control of your monitor:

10.9 To adjust Chroma and Hue using Blue Only

1. **Turn on** “Blue Only”

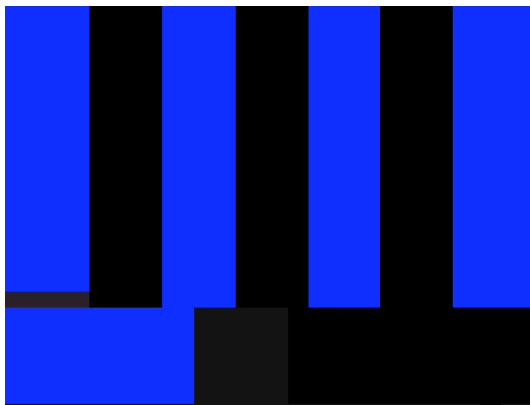

2. **Adjust** Chroma until the bar on far right is indistinguishable from the narrow bar below it.



Hue does not apply to HD-SDI or component signals. However, if you are viewing a playback from NTSC video:

Adjust Hue until the middle bars of above screen are indistinguishable from the narrow bars below them.

Monitor calibration is a critical part of digital cinematography. You should confer with Panavision technicians and your post-production house about monitor calibration before shooting.

11. How to use the Camera LCD Menu

11.1 alarm LED, Top Line Display Control

11.2 status/cancel Switch

11.3 menu vf/lcd Switch

11.4 Using the Thumbwheel with LCD menus

11.5 LCD Menu Defaults

11.6 To do a BLACK BALANCE

As briefly seen in 4.4, the LCD menu panel is the gateway to the LCD and viewfinder menus. Let's start with the LCD menu.



11.1 alarm LED, Top Line Display Push Button

alarm **red LED** indicator

Usually off, when on indicates either that camera is initializing or that there is a problem. The problem is usually described in an error message on LCD panel.

black rubber push button (to left of alarm LED)

- push to cycle through 3 different top line displays for LCD:
 - shutter degree, e.g. 180deg
 - 12 volt supply voltage and 24 volt supply voltage
 - Film type (Tungsten or Daylight) and Gain settings
- push to clear error message on LCD panel

The bottom line of the LCD display shows the frame rate

11.2 status/cancel Switch

status – Pushing UP



Push upwards to display the following information in Viewfinder1 output (only works when VF1 is in single-line mode discussed below)

FORMAT: Frame rate setting, see [chapter 14](#) for more details

CHU OUT: 444 or 422 video signal format, see [14.4](#)

ASSIGN 1-3 : settings for 3 **assign** switches, see sections [4.2](#) and [16.2](#)

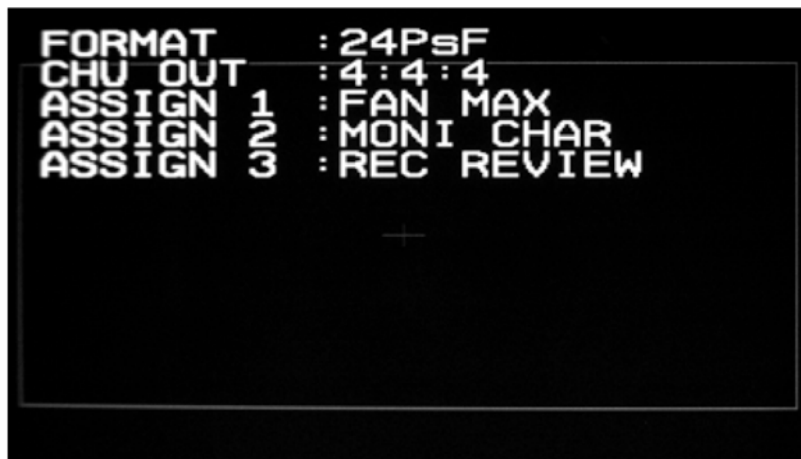

cancel – Pushing DOWN

Push downwards to jump from bottom to top line of LCD when modifying LCD menu settings

- In Viewfinder1 menus, push down to navigate backwards:
 - to change question mark cursor to arrow
 - to move arrow cursor to top of page or
 - to move from top of page to TOP MENU

For more details on Viewfinder1 menus, see [chapter 12](#)

11.3 menu vf/lcd Switch



menu vf/lcd switch is used to

1. Switch Viewfinder1 (VF1) bottom one-line display on or off

2. Display

a) Viewfinder1 menus or

b) LCD menus

and then use Thumbwheel to navigate and modify menu settings

menu vf – pushing UP

Push upwards to cycle through 3 display modes of VF1 :

1. No characters on screen
2. Bottom one-line display
3. Full screen viewfinder menu pages (use thumbwheel to navigate and modify)

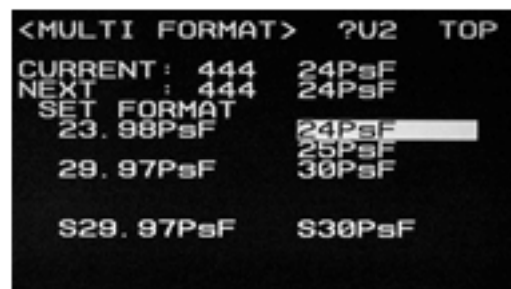

Push up to go from

VF1 one-line display -> to VF1 full screen menu

When LCD menus are active, pushing up only turns one-line display on/off.

menu lcd – pushing DOWN

Push downwards to cycle through 2 modes on LCD screen:

LCD display

LCD menu (use thumbwheel to navigate and modify)

Pushing down does nothing when VF1 menus are on

*Only one menu can be modified by the thumbwheel at a time.
Therefore when Viewfinder1 menus are displayed you cannot see
LCD menus, and vice versa.*

*For example, if the Viewfinder1 menus are displayed, clicking
vf/lcd downwards does nothing: you must first click **vf/lcd**
upwards to turn VF1 menus off before you can click downwards to
access the LCD menus.*

In general:

*If clicking the **vf/lcd** upwards does nothing, click downwards once
then click up.*

If clicking downwards does nothing, click up first then down.

11.4 Using the Thumbwheel with LCD Menu



Turning the thumbwheel clockwise or counter-clockwise moves cursor through LCD menus on top line, and can also change the settings of an item on bottom line.

Pushing the thumbwheel down jumps from top to bottom line of LCD or vice versa

The thumbwheel cursor in the green LCD menu is always indicated by a question mark ?

Turning the thumbwheel with the ? cursor in the **top** LCD row will cycle through the LCD menu items:

Auto Black, Color Bars, Shutter Speed, ECS freq, Master Gain, Film Type, Shutter On/Off...



Turn thumbwheel ...



To change LCD menu item

Pushing AUTO BLACK will do a black balance (see 11.5), otherwise

Pushing the thumbwheel will jump the question mark cursor ? between top and bottom line: down to allow you to change the settings of the current item, and up when you're done.



Push thumbwheel...



To change LCD menu line



Turn thumbwheel...



To change shutter angle

Turning the thumbwheel with the ? cursor in the **bottom** LCD row will change the options for each item:

- | | |
|-------------------------|----------------|
| on/off for color bars | gain amount |
| shutter angle value | film type |
| ECS shutter angle value | on/off shutter |

11.5 LCD Menu defaults

The Panavision Defaults for the LCD Menu items are:

COLOR BAR SW – Turn bars on or off.

The type of COLOR BAR is selected on VF1 menu page M9, see 26.3

SHUTTER SPEED – controls the electronic shutter and determines the effective exposure time for each frame.

- SHUTTER SPEED offers the following degrees:

270, 180, 173 (172,8), 144, 90, 69, 35, 17, 9 and ECS

- ECS is used to select other shutter speeds defined by ECS FREQ setting below.

As with film cameras, higher shutter numbers imply more motion blur for each frame and therefore less perceived strobing, as well as longer exposure times for each frame and therefore more exposure.

ECS FREQ – This allows you to set shutter angles from 3.8 to 360.0 degrees in 1/10 degree increments.

- At 360 degrees the camera is exposed for the entire duration of the frame time. At 24 fps, the exposure is 1/24th of a second, a full stop more than 180 degree shutter exposure time of 1/48th of a second.

ECS is also used to eliminate horizontal bars when shooting CRT monitors in a locked-off shot. ECS stands for Extended Clear Scan, a trademark Sony video term

MASTER GAIN – changes the amplification of the signal. More gain means more exposure but also more video noise.

- The gain options are: -0.5, 0, 0.5, 1.0, 1.5 and 2.0 stops

Panavision recommends that you shoot tests of a range of Gain options to see what works for you.

FILM TYPE – changes the color response of the camera

- TUNGSTEN is used with 3200 Kelvin lighting.
- DAYLIGHT is used with daylight or 5600 Kelvin lighting, although some cinematographers prefer to use an 85 filter in front of or behind the lens.
- USER allows you to set a color temperature, in degrees Kelvin. This function is rarely used.

Panavision recommends that cinematographers shoot tests to evaluate the look of non-Tungsten FILM TYPE settings.

FPS – is only active when variable frame rate has been selected on Viewfinder menu page M6. If you are in a Selectable frame rate, you must set a frame rate between 1 and 50 FPS in 1 FPS increments. See [14.8](#) and [chapter 20](#) for more details

SHUTTER ON/OFF - SHUTTER OFF is the same as "360 degree" shutter, but it is faster to implement than the thumbwheel with ECS FREQ.

Viewfinder menu USER PAGE 1 contains the 8 Menu Line Items above that are accessed via the LCD panel. Typically they are functions that are used on a daily basis. These items can be changed in the USER PAGE EDIT screen of USER MENU CUSTOMIZE described in [Chapter 15](#)

AUTO BLACK – used to calibrate the black levels of the image or to fix "stuck" pixels. This should be done on a regular basis notably

At beginning of the day, or after a break

After a significant camera temperature change

Stuck pixels are pixels that remain fixed at a given color value no matter what the image. The technical term is RPN (Residual Point Noise).

11.6 To do a Black Balance



1. **Push** vf/lcd switch down. A ? question mark should appear in LCD screen. (see 11.3 and 11.4).

If nothing happens push up to exit vf and then push down.

2. **Turn** thumbwheel ?AUTO BLACK appears in LCD screen.

3. **Push** the thumbwheel to start the AUTO BLACK process
4. The bottom line of the LCD will read EXECUTING, and the viewfinder menu will display ABB (automatic black balance).
5. Pushing AUTO BLACK activates an internal capping shutter that blocks all light to the CCD.
6. Wait for 30 to 90 seconds until the process is complete, and the word EXECUTING disappears

X

WARNING

Do not turn off the camera during an AUTO BLACK execution. Doing so may leave the camera menus in an unpredictable state.

If the camera is turned off during AUTO BLACK, you should go through all the Viewfinder menus and compare them to the Panavision Recommended Settings in [chapter 26](#)

12. How to use the Viewfinder Menus

12.1 Introduction to Viewfinder Menus

12.2 The Seven Viewfinder Menus

12.3 The Tree Structure of Viewfinder Menus

12.4 Turning Menus On & Off With vf/Lcd Switch

12.5 Using Thumbwheel To Navigate VF Menus

12.6 To move to a menu page

12.7 To go back to TOP

12.8 To toggle between ? and -> cursors

12.9 To change page

12.10 To move inside a page

12.11 To change a menu setting

12.1 Introduction to Viewfinder Menu

We now turn to the full-page menus seen on the Viewfinder outputs of the camera, which we will refer to as **VF menus** for short. Most menus are for Panavision technician use and diagnosis. As detailed in chapters 13-15, only a dozen menus are actually used by the Camera Assistant, most of them during prep.

There are 70 Viewfinder menu pages that are divided into 7 different menus which are accessed from the **<TOP MENU>**.

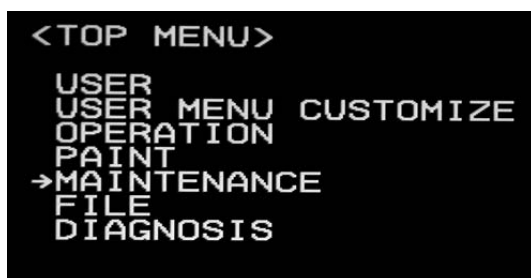

The TOP menu leads to the other 7 menus in a tree structure.

Each menu page is made up of up to 10 line items.

Each of the menu pages is identified by a descriptive name between brackets on the upper left and by a page number on upper right:

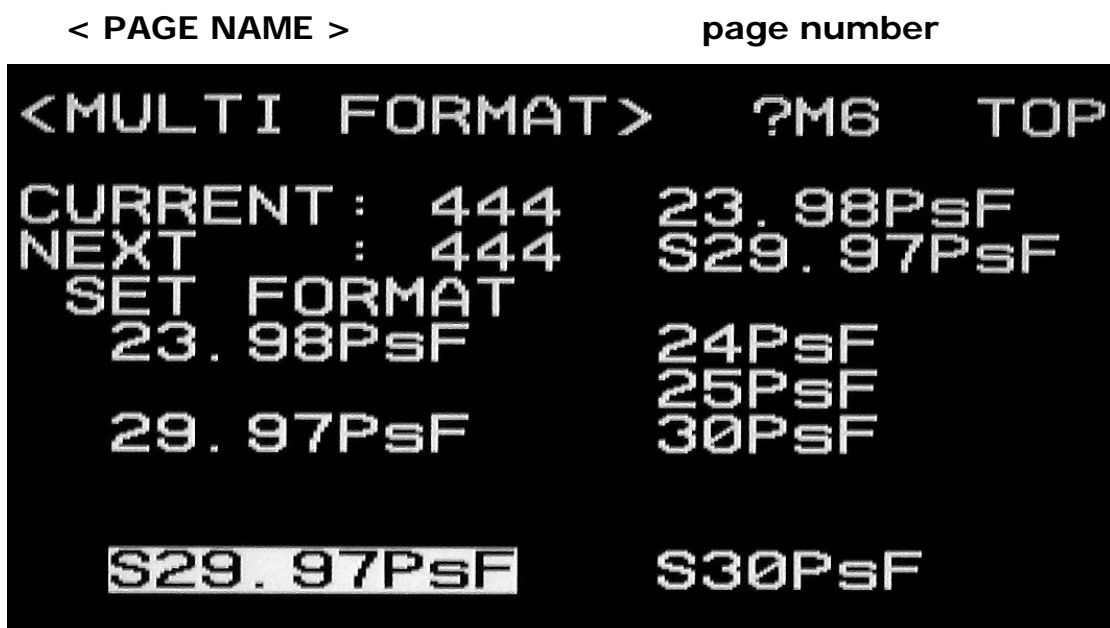

Page M6 (Maintenance 6) is called MULTI FORMAT

12.2 The 7 Viewfinder Menus

You will only need to access a few VF menu pages to use the Genesis. During prep, you will use several OPERATION pages to set up the camera for the shoot, notably to define monitor frame lines. On the set, you will use a single VF menu page, <MULTI FORMAT>, to go to and from variable frame rate. Otherwise you will mostly use the LCD menu items described in 11.5 .

USER – can be used on set

This is a handy place to copy menus you use often.

The Panavision default for the first page is <MULTI FORMAT>, a copy of page M6.

USER MENU CUSTOMIZE – can be used during prep. This is where you can customize the pages in the USER menu, and in the LCD menu.

OPERATION – used a lot during prep

This contains most of the pages you will want to set up during prep, including functions that define what is seen in viewfinder, as well as the frame lines and assignable switches

PAINT – not used

Assistants will want to check this menu during prep, but the only page that we suggest you set is P14 Video_LVL

MAINTENANCE – page M6 often used

This includes the frequently accessed MULTI-FORMAT **M6** page that allows you to change between fixed and variable speed.

FILE – can be used during prep

These pages allow you to write and read Memory Sticks. F9 can be used to transfer some Operation settings between different cameras, but can be found on page 9 of the Operator Menu.

DIAGNOSIS – only used to troubleshoot

Used to check software versions and board status with the aid of a Panavision technician

12.3 The Tree Structure of Viewfinder Menus

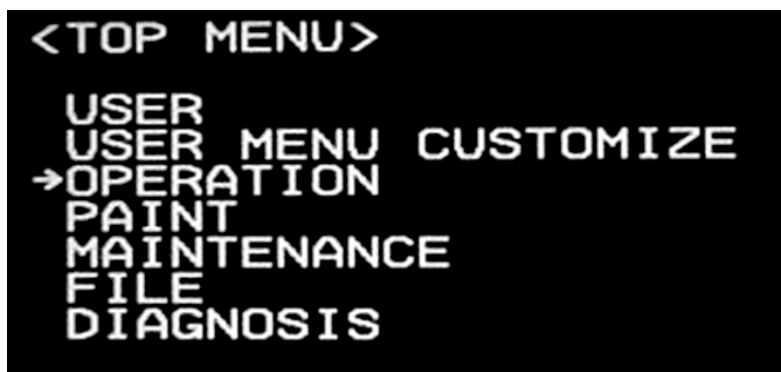

USER menu pages U1-U2 <i>used for fast M6 access</i>	→TOP
USER MENU CUSTOMIZE page U1 <i>used to define USER pages</i>	→TOP
OPERATION menu pages 1-11 (or "O1-O11") <i>used a lot during prep</i>	→TOP
PAINT menu pages P1-P14 <i>not used</i>	→TOP
MAINTENANCE menu pages M1- M11 <i>M6 used often</i>	→TOP
FILE menu pages F1-F7 <i>not used</i>	→TOP
DIAGNOSIS menu pages D1-D7 <i>only used to troubleshoot</i>	→TOP

The TOP menu is linked to 7 menus that are linked back to the TOP

12.4 Turning menus on & off with vf/lcd switch

The same menu switch and thumbwheel used with the LCD panel is also used with Viewfinder menus.



menu vf/lcd – **pushing UP**

Push upwards to cycle through 3 display modes of Viewfinder1 :

1. No characters on screen
2. Bottom one-line display
3. Full screen viewfinder menu pages

Only one menu can be active at once. When LCD menus are active, pushing UP won't give you Viewfinder menus: you will have to push down to exit the LCD menus before you push up to access VF menus.

The rule of thumb is: if pushing UP doesn't change the Viewfinder, push DOWN once and then push UP.

VF1 bottom one-line display



Clicking vf/lcd UP changes display from one-line to...

VF1 full screen menu

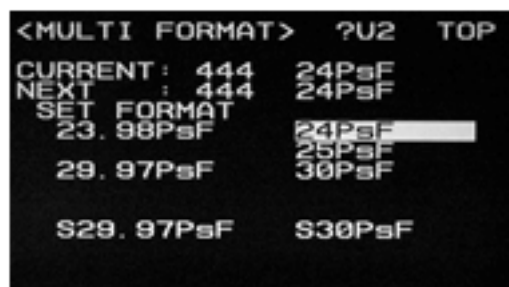

full screen pages

12.5 Using the Thumbwheel to Navigate VF menus

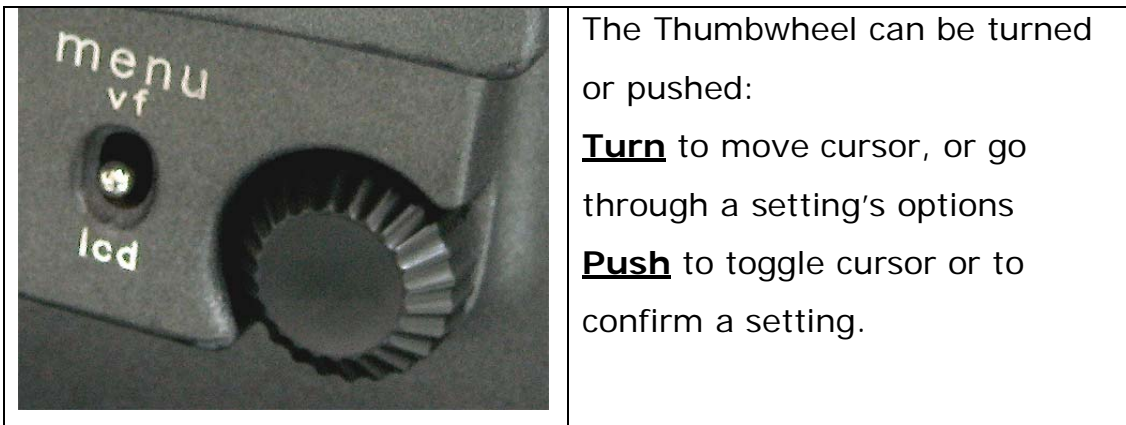

In the Viewfinder menu the thumbwheel cursor is indicated either by a static arrow -> or a blinking question mark ?

In the **TOP MENU**, the cursor is always an arrow ->

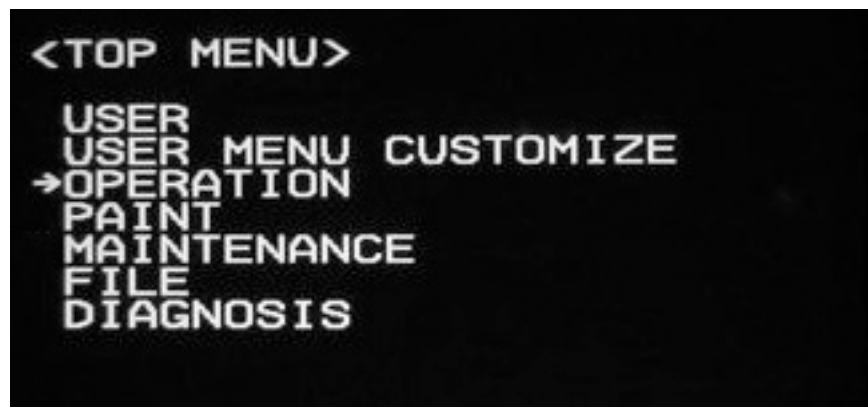

12.6 To move to a menu page

Turn thumbwheel to move arrow cursor to desired menu

Push thumbwheel to move to a page of the menu pointed at



with →MAINTENANCE push

moves to page M1



12.7 To go back to TOP

when the arrow points at TOP **push** the thumbwheel to return to the TOP menu

*You can also repeatedly click the **status/cancel** switch down towards cancel to move back up the menu tree.*

12.8 To toggle between ? and -> cursors

In most other cases, **push** when the cursor is a blinking question mark to turn it into an arrow, and vice versa

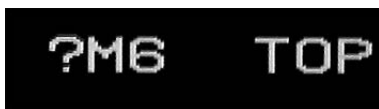

Push repeatedly to toggle

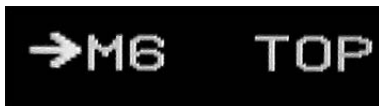

between arrow cursor



and blinking question mark cursor

12.9 To change page

To go to the next page: position a question mark to the left of the page number (in upper right), and **turn** the thumbwheel.



Turn thumbwheel ...



To go from page 4 to page 5

12.10 To move inside a page

when the cursor is an arrow, **turn** the thumbwheel clockwise to move the arrow to the left of the next item in the page. Going counter-clockwise moves the arrow to the left of the previous item.

12.11 To change a menu setting – example of menu page O8

1. **Turn** thumbwheel to position the arrow so that it points at the menu setting (SWITCH 2) that you want to change:

```
<ASSIGNABLE>      →8      TOP
SWITCH1 : FAN MAX
SWITCH2 : OFF
SWITCH3 : REC REVIEW
```

```
<ASSIGNABLE>      8      TOP
SWITCH1 : FAN MAX
SWITCH2 : →OFF
SWITCH3 : REC REVIEW
```

2. **Push** the thumbwheel to turn the cursor into a question mark in front of the item you want to change (OFF):

```
<ASSIGNABLE>      8      TOP
SWITCH1 : FAN MAX
SWITCH2 : ?OFF
SWITCH3 : REC REVIEW
```

3. **Turn** the thumbwheel to select the new setting (MONI CHAR) that you want:

```
<ASSIGNABLE>      8      TOP
SWITCH1 : FAN MAX
SWITCH2 : ?MONI CHAR
SWITCH3 : REC REVIEW
```

4. **Push** the thumbwheel to confirm the new setting, and also turn the cursor into an arrow. You're done !

```
<ASSIGNABLE>      8      TOP
SWITCH1 : FAN MAX
SWITCH2 : →MONI CHAR
SWITCH3 : REC REVIEW
```

5. To get rid of the full screen menu, push **vf/lcd** switch upwards

13. Six OPERATION Menus to Set

13.1 Overview of next 4 chapters

13.2 Six Operation menus to set during prep

13.3 OPERATION menu O1 <VF DISPLAY>

13.4 OPERATION menu O2 <'!' IND>

13.5 OPERATION menu O3 <MARKER>

13.6 OPERATION menu O4 <BOX CURSOR>

13.7 Setting Frame Lines

13.8 OPERATION menu O5 <ASPECT MASK>

13.9 OPERATION menu O11 <VF/MONI OUT>

13.1 Overview of next 4 chapters

Most of the Viewfinder menus are not used by the Camera Assistant. In the next 4 chapters we will address:

Chapter 13 OPERATION menus you may want to set during prep

Chapter 14 The <MULTI-FORMAT> menu page that is used during production to change from fixed to variable speed mode.

Chapter 15 The USER menus, for those who want to customize the LCD or USER menus during prep.

Chapter 16. The Viewfinder menus you may want to check on a regular basis.

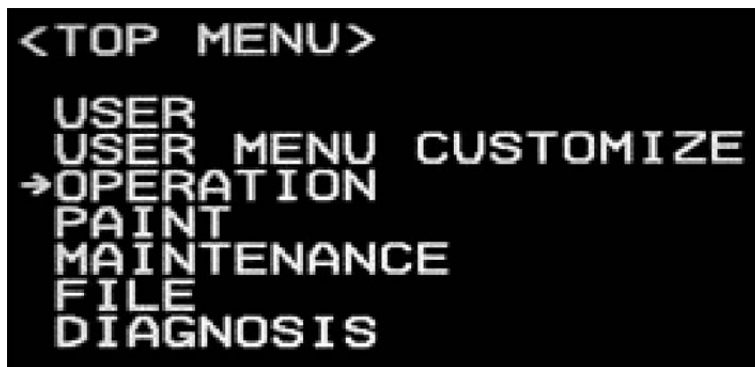

13.2 Six Operation menus to set during prep

OPERATION menu has 5 pages to set. These are usually set once during prep and then not changed again:

- page O1 setting indicators for the VF (viewfinder) DISPLAY
- page O2 setting the ! (exclamation point) alerts in the VF
- page O3 selecting the frame lines for the viewfinders & monitors
- page O4 setting and storing 2.40 and 1.85 frame lines
- page O5 setting the MASK (transparent frame matte)
- page O9 controlling video outputs

We will refer to Operation pages with the prefix letter O. For example we will refer to page 4 of the OPERATION menu as O4.

For a complete list of viewfinder menus see reference [chapter 26](#)

13.3 OPERATION menu O1 <VF DISPLAY>

```

<VF DISPLAY>      ?1      TOP
FOCUS  :  --      REC    :  OFF
T-STOP :  OFF     TAPE   :  OFF
ZOOM   :  --
F. TYPE :  ON
C. FLTR :  ON
GAIN   :  ON      MESSAG :  ALL
SHUTT  :  ON
FPS    :  ON
BATT12 :  OFF
BATT24 :  OFF

```

OPERATION Menu O1 controls what information is shown at bottom of image in VF display mode.

Each of the following indicators can be set ON or OFF:

FOCUS - not available

T-STOP - not available

ZOOM - not available

F. TYPE – TUNGSTEN, DAYLIGHT or USER

C. FLTR - not available

GAIN - Gain setting from LCD menu

SHUTT - Shutter setting from LCD menu

FPS - frame rate from menu M6

BATT12 - 12 volt battery voltage

BATT24 - 24 volt battery voltage

REC - if camera is recording

TAPE - amount of tape left

MESSAG - display of messages has several options:

ALL – All messages

WRM - Error messages and warnings only

AT - Error messages, warnings and auto setup messages

OFF - no messages

Be sure to discuss this setting with the camera operator. Some camera operators prefer a clean screen.

13.4 OPERATION menu O2 < '! ' IND >

```

< '! ' IND >           ?2   TOP
[ IND ] [ NORMAL ]
WHITE   :   ON   PRESET
GAIN    :   ON   0.0
SHUTTER :   ON   ON
FORMAT  :   ON   23.98PsF
CHU OUT :   ON   4:4:4
FAN     :   ON   AUTO1

```

This page selects the ! (exclamation mark) INDicators that will appear as a visual alert in the viewfinder to show that some camera function is in not in a “normal” state.

To activate an ! exclamation mark alert:

1. select ON in the IND (indicator) column
2. select the NORMAL state. The exclamation mark will appear when the condition is NOT in the NORMAL state.

X

If the IND is OFF, the exclamation mark will never appear, no matter what the state of the camera.

Using the page pictured above as an example, the following table explains when the exclamation mark would appear:

WHITE	! appears if White Balance is NOT Tungsten
GAIN	! appears if Gain is NOT zero
SHUTTER	! appears if Shutter is NOT on
FORMAT	! appears if format is NOT 23.98PsF
CHU OUT	! appears if Camera Head Unit output is NOT 4:4:4
FAN	! appears if fan is NOT set to AUTO1

These are not necessarily the recommended settings. Be sure to discuss this page with the camera operator to arrive at your preferred settings.

13.4 OPERATION menu O3 <MARKER>

```

<MARKER>           ?3     TOP
CENTER TYPE :      3
SAFETY SIZE :     95.0%

          [VF1] [VF2] [MONI]
MARKER :         ON   ON   ON
CENTER :         ON   ON   OFF
SAFETY :         OFF  OFF  OFF
EFFECT :         ON   ON   OFF
CURSOR :         ON   ON   ON

```

This page is used to turn frame lines and cross hairs ON and OFF in VF1 VF2 and the MONITOR outputs of the Genesis.

CENTER TYPE selects 1 of 4 types of center cross hairs.

SAFETY SIZE selects the percentage area of the 16x9 ("16 by 9") SAFETY frame only. It is not used for 1.85 or 2.40.

Every frame line can be displayed in each of 3 separate outputs:

VF1 and VF2 (the 2 viewfinder multipin plugs on camera front)

MONI (the MONITOR BNC output on side of camera).

Usually VF1 is used for the viewfinder, and MONI goes to the on-board monitor, and then onwards to other on-set monitors.

Each of the following frame lines can be individually turned ON and OFF for each of the 3 outputs:

MARKER - turns all frame lines on or off

CENTER - is the center cross hair selected above in CENTER TYPE

SAFETY - is a 16x9 safety determined by the SAFETY SIZE above

EFFECT - is the 16x9 "full aperture" or "effective" pixel area

CURSOR - is the user-definable frame you will use to sketch out 1.85, 2.40 and any other format that is not 1.78. The BOX CURSOR is defined in on page O4 discussed below.

This page should be programmed in consultation with the camera operator and director of photography

When MARKER is ON in this page, all the frame lines can then be toggled ON or OFF by means of the Viewfinder ASPECT switch.

13.5 OPERATION menu O4 <BOX CURSOR>

<BOX CURSOR>		?4	TOP
H-POSI	50	V-POSI	50
WIDTH	95	HEIGHT	50
1	2	3	STORE

The BOX CURSOR page is where you define the frame lines for 2.40 widescreen, 1.85 feature and other formats

The following numbers are in percentages:

H-POSI defines horizontal position. The default is 50%, or mid-way

V-POSI defines the vertical position. The default is 50%, or mid-way

WIDTH defines the percentage of the screen width. Typically you will want to be very close to the edges of the screen, and very close to 99%, the maximum value.

HEIGHT defines the percentage of total screen. The height will vary with the format from 99% for full-ap 1.78, to 71% for full-ap 2.39.

The bottom line of the page refers to 3 in-camera memory files where you can store and/or retrieve your BOX CURSOR settings.

To Store a Scene File in 1 of 3 camera memory files

1. Select STORE
2. Select the file number to store to 1 2 3

To retrieve a Scene File from 1 of 3 camera memory files

1. Select the file number to retrieve from: 1 2 3

Reminder: the SAFETY and EFFECT markers on the previous OPERATION page O3, only display safe action and full aperture for 1,78 (16 by 9) and not for any other format.

13.6 Setting Frame Lines

Again, BOX CURSOR is used to set Frame lines. Here are some common settings (H and V positions are always 50) for safe action and full aperture. Genesis full aperture is approximately equivalent to Super-35 film.

Aspect Ratio Format	Width	Height		Width	Height
	(percentages)			(pixels)	
Panavision suggested safe action values					
2.39 film	95	71		1824	764
1.85 film	95	91		1824	987
1.78 tv transmitted	95	95		1824	796
1.33 common H	71	95		1363	1024
full aperture					
2.39	99+	74		1920	796
1.85	99+	95		1920	1029
1.78 tv transmitted	99+	99+		1920	1080
1.33 common H	71	99+		1420	1080

Note: there are 5 thumbwheel "clicks" (intervals) between each percentage integer. For example you have to click the thumb wheel 5 times to get from 98 to 99 percent. 99+ above indicates 99 and 5 clicks.

The formula to calculate Width and Height percentages is:

Width = desired safe action percentage

Height = (1.78 / Aspect Ratio) x Width

Example for 2.39 aspect ratio 94% safe action

Width = 94

Height = (1.78 / 2.39) x 94

Height = 70.01 Height (rounded off) = 70

13.7 OPERATION menu O5 <ASPECT MASK>

```

<ASPECT MASK>    ?5    TOP
VF                : OFF
MONITOR           : OFF
MODE              : VAR H
VAR WIDTH        : 1764H
LEVEL             : 50

```

This page allows you to set a transparent MASK to isolate the desired ASPECT ratio on the image.

This feature is especially useful for control of the MONITOR output, to help isolate the frame for the director.

VF : turns the MASK ON or OFF in the Viewfinder

MONITOR : turns the MASK ON or OFF in the MONITOR BNC output

MODE:

- VAR H enables a variable horizontal width defined in VAR WIDTH
- VAR V enables a variable vertical width defined in VAR WIDTH

The MASK function mask can be aligned with either the vertical or the horizontal frame lines, but not both!

VAR WIDTH – Turn thumbwheel to dial in the desired width in pixels (NOT percentage). The best method is to align the mask with the frame lines you defined with the BOX CURSOR on page O4.

The full CCD imaging area is 1920 pixels H by 1080 V

LEVEL : Dial in the desired transparency of the MASK. Best done with an image. The transparency options are:

0 (black border/no transparency), 12.5, 25 and 50%.

Note that when MASK is ON in this page, it can then be toggled ON or OFF by means of the DISPLAY switch on the Viewfinder.

To toggle: repeatedly click top switch to the right toward DISPLAY.

See [5.4](#)

13.9 OPERATION menu O11 <VF/MONI OUT>

```

<VF/MONI OUT>      11  TOP
VF1/2
  OUTPUT           : COLOR
  PB AUTO         : OFF
MONITOR
  OUTPUT           : COLOR
  PB AUTO         : ON
VF/MONI GAMMA     : OFF
VF1 CHARACTER     : ON
MONI CHARACTER    : →OFF

```

This page allows you to select the signal sent to VIEWFINDER 1 and 2 and the MONITOR BNC output on the Genesis

OUTPUT to VF1/2 (viewfinders 1 and 2) or MONITOR (main video output see [10.1](#))

COLOR – Panavision recommended setting

B&W

PB AUTO

ON – VF1/2 or MONITOR will automatically display playback from the on-board SRW-1 VTR when it occurs

OFF – VF1/2 or MONITOR will display the live camera regardless of playback.

PB AUTO OFF can be selected if the director does not want to see the signal when you do REC REVIEW.

VF/MONI GAMMA: OFF

Do not turn VF/MONI gamma ON, as the monitor will display an image with incorrect gamma

VF1 CHARACTER

ON – The standard setting: single line and full page menus will appear in the viewfinder

OFF

If you put VF1 CHARACTER OFF, you will no longer see menus in VF1. To turn the menus back ON, plug the viewfinder in to VF2, whose menus are always on. See [10.1](#)

MONI CHARACTER

ON – Viewfinder menus (characters) will appear on the video coming out of MONITOR BNC on camera, which is usually connected to the Astro and the other monitors on-set. See

10.1

OFF - menus will not appear on the on-set monitors.

*MONI CHARACTER ON/OFF can be done with the **assign 2** switch on the Camera Left Side. See **4.2***

*Some Camera Assistants leave both VF1 and MONI CHAR OFF and use the REF OUT to access menus on the Astro without disturbing the Camera Operator or Director. See **10.4***

14. Setting the <MULTI FORMAT> Page

14.1 <MULTI FORMAT> Overview

14.2 <MULTI FORMAT> top and bottom

14.3 About the recording format options

14.4 The 444 recording formats

14.5 The 422 recording formats

14.6 Fixed Speed or Selectable variable speed

14.7 To change fixed speed format on page U1 or M6

14.8 To change format on U1 or M6 for variable speed

At present, the SRW-1 cannot record the following fixed frame formats: 30PsF and 60I.

Also, at present, the SRW-1 cannot record variable speed correctly when it is not mounted on the Genesis camera. Contact your Panavision technical representative for more information.

14.1 <MULTI FORMAT> Overview

The MULTI FORMAT page is used to set the production frame rate, and sampling and interlace video formats during prep.

MULTI FORMAT is also used during production to switch back and forth between fixed speeds (like 23.98, 24 and 25 fps) and ranges of variable speeds (like S23.97, S30, 59.97 and S60).

The MULTI FORMAT page is one of the most frequently used menus and it is available either in the USER menu, as U1 the first page, or in the MAINTENANCE menu as page M6.

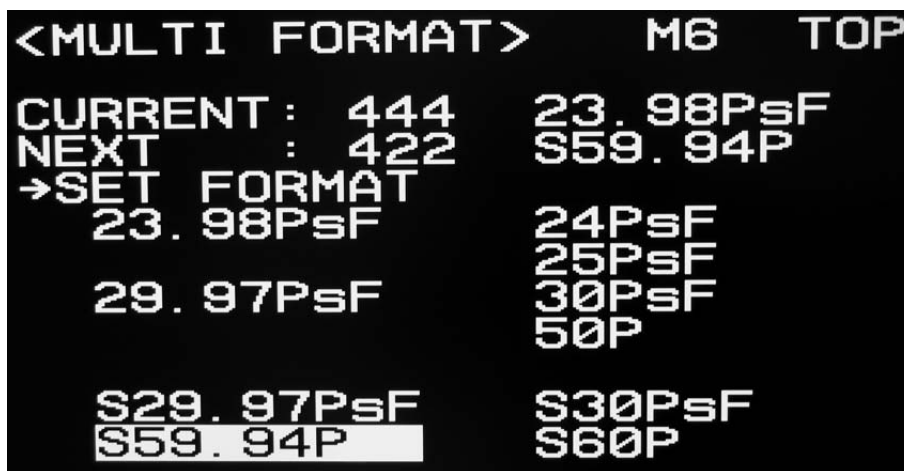

CURRENT

displays the sampling (444 or 422) and frame rate (from 23.98PsF to 60I) format of the Genesis camera and on-board SRW-1

NEXT

displays the sampling and frame rate that the Genesis camera and on-board SRW-1 will switch to, after you select SET FORMAT

SET FORMAT

When the arrow cursor is pointing at SET FORMAT, pushing the thumbwheel reboots the Genesis and attached SRW-1 VTR, setting both to the NEXT format.

14.2 <MULTI FORMAT> top and bottom

The MULTI FORMAT page is different from other menus, in that the frame rate choices appear in 2 places:

1. On the right-hand side of the NEXT line at the top

```

<MULTI FORMAT>   ?M6   TOP
CURRENT : 444     23.98PsF
NEXT     : 444     S29.97PsF
SET FORMAT
  
```

2. Highlighted in a white rectangle in the bottom half of the screen.

```

23.98PsF          24PsF
                  25PsF
29.97PsF          30PsF
                  50P
S29.97PsF         S30PsF
S59.94P           S60
  
```

The frame rate setting is done on the NEXT line at the top, not on the bottom.

The bottom area below SET FORMAT only serves to show the range of possible frame rate choices, while the white rectangle indicates the current selection on the NEXT line.

The available frame rate choices at the bottom will change to reflect your selection of 444 or 422 on the NEXT line.

14.3 About the recording format options

444 stands for 4:4:4 R G B

The 4:4:4 is the full bandwidth uncompressed signal of the Genesis. 4:4:4 (444 for short) stands for an even ratio between the Red, Green and Blue components of the signal. 444 has more information than 422

422 stands for 4:2:2 Y Cb Cr

4:2:2 is a way of compressing the 4:4:4 signal to achieve less data. 4:2:2 represents the ratio of Luminance (Y) information to the Blue and Red digital color difference signals. The actual ratio is an old historical reference to multiples of NTSC sub-carrier. The important thing to retain is that, for every 4 samples of luminance, there are 2 samples of each of the color difference components.

P stands for Progressive Scan

In Progressive Scan the entire frame is captured at once, like film.

I stands for Interlace Scan

Interlace Scan means that every odd line (lines 1, 3, 5, etc) is captured in one moment, and then every even line (lines 2, 4, 6 etc) in the next moment. Interlace scan is typically used in television broadcast.

sF stands for Segmented Frames

Segmented Frame means that the Progressive Frame is broken down into 2 Fields (half-frames) for recording purposes

14.4 The 444 recording formats

The 4:4:4 RGB sampling format is associated with 5 fixed frame rates and 2 variable frame capture settings.

The 5 fixed frame rates for 444 are:

23.98PsF (23.98 fps Progressive Scan segmented Frame)

24PsF (24 fps Progressive Scan segmented Frame)

25PsF (25 fps Progressive Scan segmented Frame)

29.97PsF (29.97 fps Progressive Scan segmented Frame)

30PsF (*30 fps Progressive Scan segmented Frame*)

Note that, while the Genesis can be set at 30PsF, the SRW-1 VTR cannot record a 30PsF fixed frame rate signal.

The SRW-1 can however record a variable speed of S30PsF

The 2 variable speed 4:4:4 ranges are:

S29.97PsF (S stands for “Selectable”). Select this option if you want variable speed for a 23.98 fps or 29.97 fps production.

S30PsF. Select this option if you want variable speed for a 24 or 25 fps production.

Note that S29.97 and S30 represent ranges of variable speeds from 1 to 30 fps. The actual recording speed is set using FPS on the LCD Menu Panel, as seen in [14.8](#)

The rule to remember is that selectable variable speed ranges with decimal points go with fixed frame rates with decimal points, and vice-versa. That is: use S30 with 24 or 25 fps, and S29.97 with 23.98 and 29.97 fps.

14.5 The 422 recording formats

In most feature applications 422 is used when shooting variable speed ranges above 29.97 fps (S59.94 or S60), because these high data rates don't allow for 444.

Panavision does not recommend using 422 when shooting 29.97 fps or less, even when the intended release will be 422.

The 4:2:2 YCbCr sampling format is associated with the following fixed frame rates:

23.98PsF (23.98 fps Progressive Scan segmented Frame)

24PsF (24 fps Progressive Scan segmented Frame)

25PsF (25 fps Progressive Scan segmented Frame)

29.97PsF (29.97 fps Progressive Scan segmented Frame)

30PsF (30 fps Progressive Scan segmented Frame)

59,94I (59.94 fps Interlace Scan)

60I (60 fps Interlace Scan)

At present, the SRW-1 VTR cannot record a 30PsF or 60I fixed frame rate signal.

The 422 variable speed capture ranges are:

S29.97PsF (S stands for "Selectable"). Select this option if you want variable speed for a 23,98 fps or 29,97 fps project.

S30PsF. Select this option if you want variable speed for a 24 or 25 fps project.

S59,94P fps for a 23,98 fps or 29,97 fps project.

S60P fps for a 24 or 25 fps project.

The rule to remember is that select variable speed ranges with decimal points go with fixed frame rates with decimal points, and vice-versa. That is: Use S30 or S60 with 24, 25, 60 fps
Use S29.97 or S59.94 with 23.98 and 29.97 fps.

14.6 Fixed Speed or Selectable variable speed

There are two types of format changes: fixed speed and variable speed. Fixed speed is the sync sound speed you will be shooting most of your project in. For American features this is usually 23.98.

Variable speed is an in-camera special effect used to do slow motion or accelerated action. As with film, shooting variable speed means recording at one speed and playing back at the project fixed speed, sometimes referred to as the “target” speed.

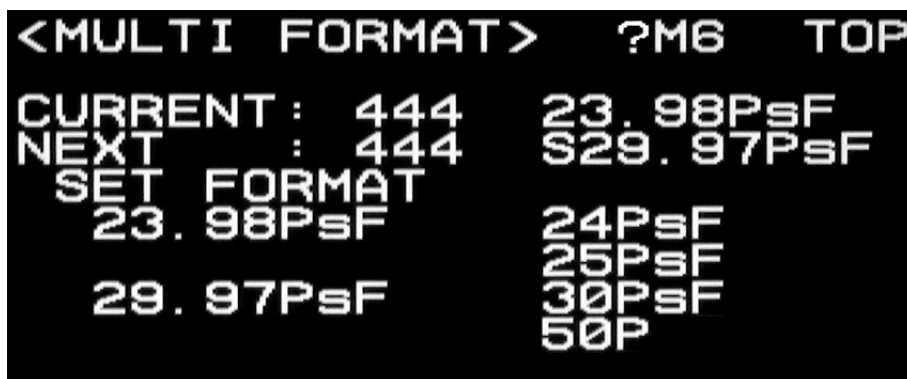

The options for Selectable speed ranges are on the bottom 2 lines of the MULTI FORMAT page, with an **S** prefix.



Setting the variable speed involves 2 parts:

1. You **SET FORMAT** the Genesis to a **Selectable** speed range that corresponds to the fixed speed playback. The rule to remember is that fixed speeds with decimal points require **Selectable** speed settings with decimal points. For example, if you are shooting 23,98 fps fixed speed, you will select S29,97 or S59,94 (and not S30 or S60).
2. You then select the actual **FPS** you want in the range of available variable speeds. This is done on the LCD panel. See [14.8](#)

A mismatch at the time of recording between the Selectable range (e.g. S59.94 or S60) and the Target playback rate (e.g. 23.98 or 24) and can lead to errors in subsequent playback (e.g. Time Code interruptions or loss of LOCK).

14.7 To change camera format to a fixed speed:

Go to <MULTI FORMAT> page in USER menu (or page M6)

1. **Turn** thumbwheel to position arrow on the NEXT line
2. **Turn and Push** thumbwheel to select sampling format 444 unless you are shooting 59.94 or 60 fps.
3. **Turn and Push** thumbwheel to select desired frame rate (23.98 etc...)
4. **Turn** thumbwheel to position arrow in front of SET FORMAT
5. **Push** thumbwheel to confirm new format.

A few seconds later, the camera and VTR will automatically change formats

6. CURRENT will then display the new format

X

When the SRW-1 VTR is attached to the Genesis, there is no need to change the format on the VTR, as it will automatically follow the camera setting.

When the SRW-1 VTR is separated from the Genesis, you must change the format in the VTR Menus, as well as the camera Menus Go to [21.10](#) to see how to change format on VTR.

14.8 To change format to a Selectable variable speed range

Go to <MULTI FORMAT> page in USER menu (or page M6)

1. **Turn** thumbwheel to position arrow on the NEXT line
2. **Turn and Push** thumbwheel to select sampling format:
 - a) 444 if you will be shooting 29.97 fps or less
 - b) 422 if you will be shooting above 29.97 fps.
3. **Turn and Push** thumbwheel to select desired frame rate:
 - A) If you are shooting 23.98 or 29.97 PsF select:
 - a1) S59.94 if you will be shooting above 29.97 fps
 - a2) S29.97 if you will be shooting 29.97 or less
 - B) If you are shooting anything else, select:
 - b1) S60 if you will be shooting above 29.97 fps
 - b2) S30 if you will be shooting 29.97 fps or less
4. **Turn** thumbwheel to position arrow in front of SET FORMAT

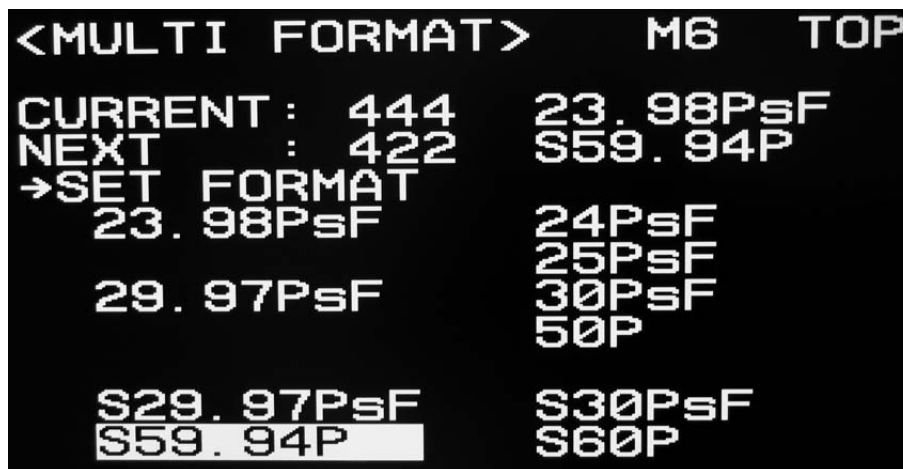

5. **Push** thumbwheel to confirm new format. A few seconds later, the camera and VTR will automatically change formats
6. **CURRENT** will display the new format

You must now turn your attention to the **vf/lcd** switch next to the Thumbwheel, and the LCD screen above it.



7. **Click up** vf/lcd switch once to leave Viewfinder menu
8. **Click down** vf/lcd menu down to activate LCD menu
9. **Push** thumbwheel to enter LCD menu items

10. **Turn** thumbwheel to select FPS on top row of LCD Menu Panel



11. **Push** thumbwheel to position question mark cursor on bottom row
12. **Turn** thumbwheel to change fps setting to desired one
13. **Push** thumbwheel to confirm fps setting
14. **Click up** vf/lcd switch once to exit LCD menu

You're ready to shoot.

X

At present, the SRW-1 can only record Selectable variable speed correctly if it is mounted on the Genesis camera. Consult your Panavision technical representative for more information.

For more information about variable speed, See **chapter 20**

15. Setting Viewfinder USER menus

15.1 USER and USER MENU CUSTOMIZE

15.2 USER MENU CUSTOMIZE <PAGE EDIT>

15.3 To add entire pages to the USER Menu

15.4 USER MENU CUSTOMIZE <USER P1 EDIT>

15.5 To add a menu line item to the LCD Menu

15.1 USER and USER MENU CUSTOMIZE

The USER Menu pages are a place for the user to put copies of frequently- used pages from the other Menus for easy access. The USER Menus are defined by settings in the USER MENU CUSTOMIZE menu right below it.

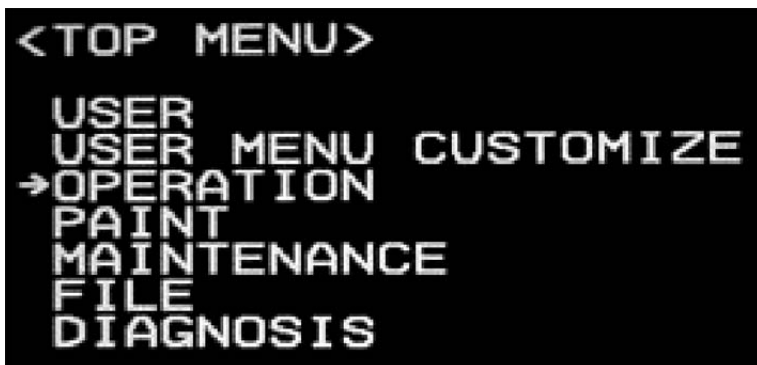

The USER Menu cannot be blank, there must be at least 1 page. The Panavision default for the first USER page is <MULTI-FORMAT>, also located on page M6. Note that the page is identical to M6, except that it is labeled **U1**.

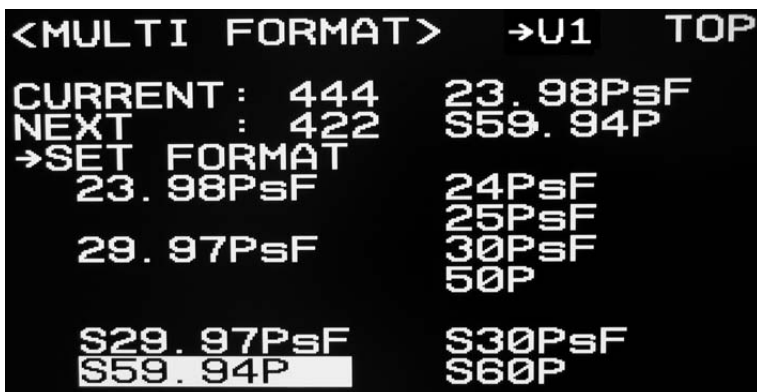

Note that the U1 page number could be confusing as there are 2 possible U1 pages (one in USER and one in the USER MENU CUSTOMIZE). So we will reserve U1 for the USER MENU.

15.2 USER MENU CUSTOMIZE <PAGE EDIT>

```

<PAGE EDIT>      ?U1  TOP
PAGE :  1/1
1 : <MULTI FORMAT>
2 : -----
3 : -----
4 : -----
5 : -----
6 : -----
7 : -----
8 : -----
9 : -----

```

<PAGE EDIT> defines the contents of the USER MENU.

The Panavision default is MULTI FORMAT for the first USER page.

<PAGE EDIT> is the first screen of USER MENU CUSTOMIZE and is labeled U1, but this could be confusing as there are 2 possible U1 pages (one in USER and one in USER MENU CUSTOMIZE). So it's best to refer to it as <PAGE EDIT>.

<PAGE EDIT> lets you define the menu pages that you would like to copy to the USER menu. Each page is copied in its entirety. When a menu page has been copied its name appears in the numbered list.

As depicted above, the Panavision default for the first USER page is <MULTI FORMAT>, a copy of page M6.

The first screen (PAGE 1/1) of <PAGE EDIT> stores up to 9 USER pages. If you had a 10th page, it would appear on "PAGE 2/2" and so on, however it's rare to see more than 9 USER pages.

15.3 To add entire pages to the USER MENU

1. In TOP MENU select USER MENU CUSTOMIZE
2. In <PAGE EDIT>, **turn** thumbwheel to item 2, which corresponds to second USER page.
3. **Push** thumbwheel to select item 2 An alphabetic list of all the page names will appear.
4. **Push** and **Turn** thumbwheel to navigate through all fifty-some of the existing menu pages,
5. **Push** thumbwheel to select the name of the page you want to copy
6. For each page you select you will have the option to
 - SELECT – confirm your page choice
 - MOVE – change the position of the selected page
 - DELETE the page
 - RETURN to the preceding screen
7. **Push** thumbwheel at SELECT
8. You will return to <PAGE EDIT> and the name of the page you chose will appear in item 2.
9. **Push** TOP to exit to TOP Menu
10. The new page(s) you added will appear in the USER MENU after MULTI FORMAT.

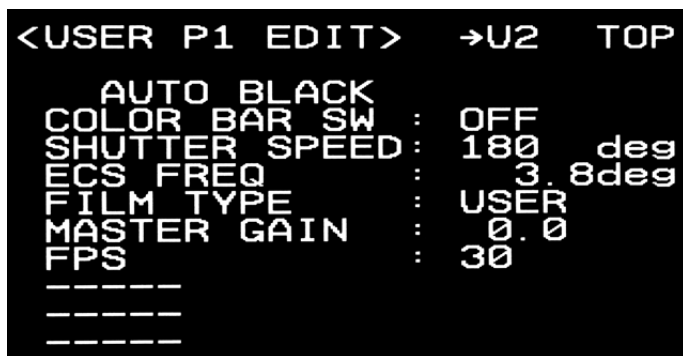
15.4 USER MENU CUSTOMIZE <USER P1 EDIT>

<USER P1 EDIT> is a page in USER MENU CUSTOMIZE that enables you to define the menu line items that are accessed via the LCD panel on the camera body

<USER P1 EDIT> (or U2) comes after **<PAGE EDIT>** described above. **<USER P1 EDIT>** enables you to define the individual menu line items (as opposed to entire pages) that are accessed via the LCD panel on the camera body. The Panavision defaults are pictured above and are more fully explained in [11.4](#)

Note that <PAGE EDIT> copies entire menu pages into the USER menu, while <USER P1 EDIT> copies a single line item from a menu page into the LCD menu.

15.5 To add a menu line item to the LCD menu

1. In TOP MENU select USER MENU CUSTOMIZE
2. In <USER P1 EDIT>, **turn** thumbwheel to position cursor at the first blank line at the bottom of the page.
3. **Push** thumbwheel to select this blank line. An alphabetic list of all the menu line items will appear.
4. **Push** and **Turn** thumbwheel to navigate through the hundreds of existing menu line items
5. **Push** thumbwheel to select the name of the menu line item you want to copy
6. For each line item you select you will have the option to
 - SELECT – confirm your page choice
 - MOVE – change the position of the selected page
 - DELETE the page
 - RETURN to the preceding screen
7. **Push** thumbwheel at SELECT
8. You will return to <USER P1 EDIT> and the name of the line item you chose will appear at the bottom of the list.
9. **Push** TOP to exit to TOP Menu
10. The new line item(s) you added will appear as the last item in the LCD menu

16. VF Menus To Check Regularly

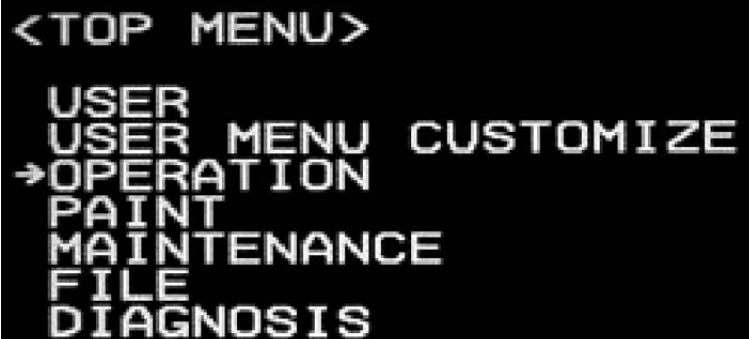

```
<TOP MENU>
USER
USER MENU CUSTOMIZE
→OPERATION
PAINT
MAINTENANCE
FILE
DIAGNOSIS
```

16.1 Checking Viewfinder Menus

16.2 OPERATION menu O8 <ASSIGNABLE>

16.3 PAINT menu page P1 <SW STATUS>

16.4 PAINT menu page P3 <GAMMA>

16.5 PAINT menu page P14 <SELECT FPS>

16.6 MAINTENANCE menu M10 <OTHERS 2>

16.7 DIAGNOSIS menus D1-D4

16.1 Checking Viewfinder Menus

This chapter details the menus that the Camera Assistant may want to check during prep, and on a regular basis during the shoot.

OPERATION menu has 1 page to check:

- page O8 the ASSIGNABLE switch on the camera body

PAINT menu has 3 pages to check:

- page P1 overview for quick check page
- page P3 checking that the PANALOG_4 GAMMA is set
- page P14 checking VIDEO_LVL and ACCUM settings which are only displayed in variable speed mode

MAINTENANCE menu has 1 page to check:

- page M10 check a grab-bag of items including FAN MODE and LCD CONTRAST

FILE there are no basic menus to check.

DIAGNOSIS has 4 pages in menu which may be useful for troubleshooting

USER The default for page 2 is a copy of the M6 multi-format page

USER MENU CUSTOMIZE there are no basic menus to check.

For a complete list of viewfinder menus see [Chapter 26](#) in the Reference section of the manual.

16.2 OPERATION menu O8 <ASSIGNABLE>

This page defines the functions attributed to the **assignable** switches on the camera body.

The 7 options for each switch are:

OFF - no function assigned

FAN MAX - used to cool off a camera in a hot environment, see page M10 (16.6) for other fan options.

VF1 MARKER – turns the frame lines in the Viewfinder ON/OFF

VF1 ZEBRA – turns the zebra in the Viewfinder ON/OFF

MONI CHAR – turns all the characters (menus) in the Genesis MONITOR output ON/OFF

VF PLAYBACK – Only active when videotape is played back on the on-board VTR. When this is the case, the switch will toggle the viewfinder video between playback and live video.

REC REVIEW - The REC REVIEW function automatically rewinds the tape, and plays back the last 3 seconds of the footage recorded on tape, and then cues the tape for the next recording. Many Camera Assistants use REC REVIEW as a digital version of "checking the gate".



The Panavision defaults for the **assignable** switches are:

SWITCH1: FAN MAX

SWITCH2: MONI CHAR

SWITCH3: REC REVIEW

16.3 PAINT menu page P1 <SW STATUS>

```

<SW STATUS>          ?P1  TOP
FLARE      : OFF
GAMMA     : ON
BLK GAM   : OFF
KNEE      : (OFF)
WHT CLIP  : OFF
DETAIL    : OFF
LVL DEP   : OFF
SKIN DTL  : OFF
MATRIX    : OFF

```

PAINT menu page P1 provides a quick check that all the Paint functions are OFF except for GAMMA

Panavision strongly recommends leaving the PAINT functions OFF, putting them ON will change the color rendition of the camera and limit the latitude of the image.

16.4 PAINT menu page P3 <GAMMA>

```

<GAMMA>              ?P3  TOP
LEVEL : [R] [G] [B] [M]
COARSE : --
TABLE  : USER
        : 1  PanaLog4
GAMMA  : ON
TEST   : OFF

```

page P3 provides a quick check that the GAMMA TABLE used is **PanaLog4**

Panavision strongly recommends using the Panalog4 gamma table which is designed to give you the maximum exposure latitude in the image.

16.5 PAINT menu page P14 <SELECT FPS>

```

<SELECT FPS>        P14  TOP
FORMAT   : S29.97PsF
FPS      : 16
VIDEO-LVL : ?CONST(GAIN)
VF SCAN  : NORMAL

```

page P14 is only active when you are running in variable speed mode: S29.97, S30, S59.97 or S60

Panavision recommends

VIDEO-LVL: CONST (GAIN)

VF SCAN: NORMAL

See [20.13](#)

16.6 MAINTENANCE menu M10 <OTHERS 2>

```

<OTHERS 2>           ?M10 TOP
FAN MODE              : AUTO1
MENU RESUME           : ALL
DATE TYPE             : 5 M/D/Y
IMAGE INVERT         : OFF
LANGUAGE              : FILM
LCD CONTRAST         : 3
MONO CHAR             : OFF
  
```

A varied page with controls for fan, date, image inversion, menu language, LCD contrast and characters out.

FAN MODE controls the modes and noise of the camera built-in fan

AUTO1 is the Panavision recommended mode. VTR fans are off during recording, but the quiet low-speed fans in the camera stay on.

AUTO2 *will leave all fans off during recording.*

MIN - minimum fan, Panavision does not recommend this mode

MAX - maximum fan, use when camera is very hot.

The MAX FAN MODE is more easily accessed on **assign 1** switch on the left side of camera. See [4.2](#)

No matter what the FAN MODE, the Genesis camera will turn the fans on to protect itself from damage, when internal temperatures are very high. Thus, for example, the camera may turn the fans on during extremely long takes, or in very hot environments.

If you are shooting extremely long takes or are in a very hot environment, Panavision recommends turning on the MAX FAN mode in between takes to cool off the camera.

MENU RESUME defines what menus will appear when you return to Viewfinder menus from another mode.

ALL is the Panavision recommended mode.

TOP means you will always return to the TOP menu

OPE means you will always return to the OPERATION menu

OFF means there will be no memory of consulted menus

To turn all the Menus back on, keep Thumbwheel pushed down and click vf/menu button upwards.

DATE TYPE for selection of the format of the DATE on page M5

IMAGE INVERT will invert the image output

LANGUAGE determines terminology for the following menu terms:

FILM	VIDEO
STOPS	DBs (decibels)
TUNGSTEN	3200K
DAYLIGHT	5600K
SHUTTER ANGLE	FRACTION OF SECOND

LCD CONTRAST adjust contrast on LCD panel on camera body. The range is from 1 to 5

MONO CHAR This menu function enables you to change the color of the characters superimposed on the Viewfinder. The options are White, Black, R, G and B). This is used on the rare occasion when the predominant color of a picture (say a bright white background) makes reading type difficult.

16.7 DIAGNOSIS menus D1-D4

The 4 pages of the DIAGNOSIS menu may be consulted when troubleshooting a problem, or when speaking with a Panavision technician about a problem.

```
<VTR/CA STATUS> ?D1 TOP
DOCKING
TOP : NONE
REAR : VTR
```

D1 confirms the VTR connection, and indicates which port the VTR is connected to

```
<ROM VERSION> ?D2 TOP
[ROM]
SY:V1.10
[PLD]
TG :V- --
PRE12 :V1.13
PRE3 :V1.01
FRAME12 :V1.04
SFCONV :V1.03
POST :V1.13
TR :V1.07
```

D2 indicates menu software version numbers.

```
<BOARD STATUS> D3 TOP
(CAM)
OHB :OK
PP :OK
FM :OK
PR :OK
IF :OK
AD :OK
TR :OK
```

This troubleshooting page indicates the status of the camera circuit boards.

```
<SDI> D4 TOP
OPTICAL LEVEL:NO SIGNAL
```

D4 is not used.

17. How to use VTR Menus

17.1 VTR navigation buttons and thumbwheel

17.2 The 5 menu buttons

17.3 Four VTR Main Menu Screens

IMPORTANT

When the SRW1 is mounted on the Genesis, any setting you enter on the camera (like frame rate and 444/422 selection) will automatically override settings entered in the VTR.

So when you are working with the VTR mounted on the Genesis, you will only need to access VTR controls to do the settings that are not available in the Genesis. On the set these are usually:

EJECT the tape housing to change tapes

Changing Time Code hour after tape change (See 18.2)

Set-up of Audio Level (See 19.4)

17.1 VTR navigation buttons and thumbwheel

The SRW-1 VTR has its own set of menus. To navigate the VTR menus and change settings you will use both the square buttons on the left of the LCD screen and the SELECT/ENTER thumbwheel and BACK push button on the right of the screen.



Push a left-hand button to go to a menu

Use thumbwheel to
Navigate menus &
Change settings



Push the **BACK** button to cancel setting or to return to previous menu

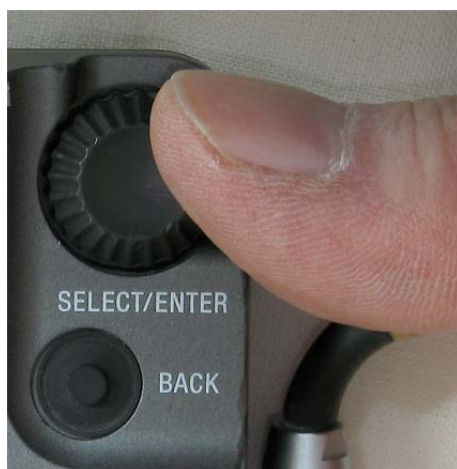

Turn thumbwheel to **SELECT**



Push thumbwheel to **ENTER**

17.2 The 5 menu buttons

You can jump from one menu to the top screen of any other menu at any time by pushing the corresponding rectangular black menu button on the left side of the panel:



HOME – the main screen with audio levels, status and error information, time code and format and other info – see 7.2 for more information about the HOME menu.

TC – the menu for all time code settings

VIDEO – an empty menu, unless the SRW-1 is mounted on the SRPC "Toaster". See 27.3

AUDIO – the menu for all audio settings

SYSTEM – the menu for format and other settings

To go back to main screen, push HOME once, rather than BACK repeatedly.

Remember that when the VTR is mounted on the camera, Genesis format settings (like format and frame rate) override VTR settings.

WARNING

Do not change a menu setting that you do not fully understand, doing so could jeopardize your shoot !

17.3 Four VTR Main Menu Screens

Most of the SRW-1 menus have a main screen with a list of selectable items that lead to other windows and screens where you can adjust settings. The exceptions are the HOME menu, and the VIDEO menu which is empty when the VTR is connected to the Genesis camera.

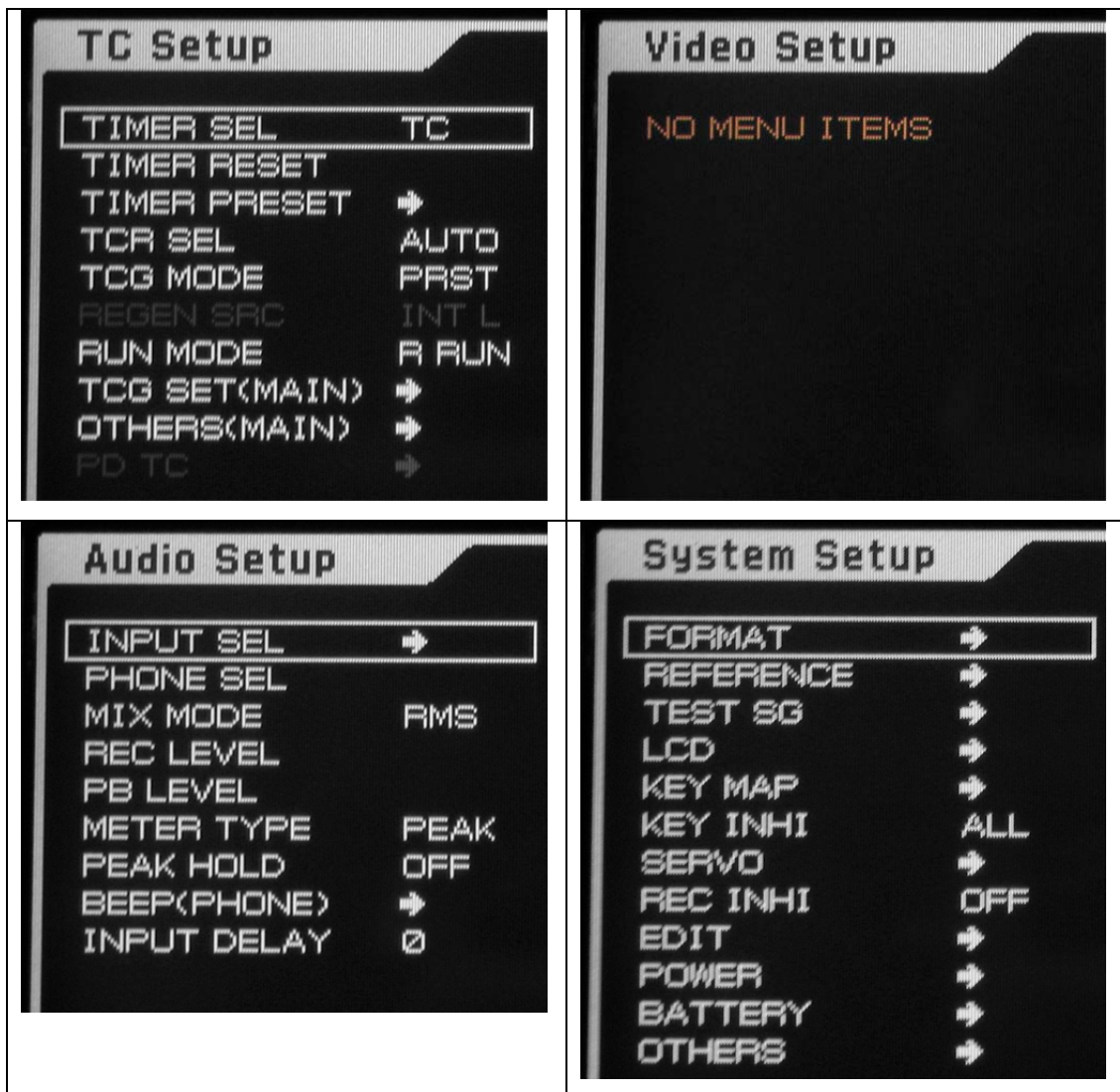

The selected item in a menu is surrounded by a **white cursor box**.

Turn the thumbwheel to select the desired item in the list
(this moves the cursor box up and down the list)

Push the thumbwheel to go into the settings of the line item.

To see Panavision's recommended settings for all the VTR menus go to [chapter 27](#)

18. VTR Menu Time Code Settings

18.1 About Time Code

18.2 To change PRESET TC hour before new tape.

18.3 Recommended Time Code settings (Internal TC)

18.1 About Time Code

SRW-1 Time Code settings depend on the post-production workflow defined by the production and post house.

The Camera Assistant needs to get the production Time Code requirements at the very beginning of the project.

Time Code is read as 4 pairs of numbers separated by colons defining hours : minutes : seconds : frames.

For example,

09:50:59:20 is read as

9 hours 50 minutes 59 seconds and 20 frames

The number of frames per second depends on the production fixed frame rate.

For example, on a 23.98 fps shoot

14:40:35:23 will be followed by

14:40:36:00

As another example, on a 29.97 fps shoot

14:40:35:29 will be followed by

14:40:36:00

Time Code “midnight” occurs after 23 hours.

For example, on a 23.98 fps shoot

23:59:59:23 will be followed by

00:00:00:00.

Some post-productions prefer not to have a midnight crossing in the time code. Consult your post-production house for their recommendation.

Many productions use the hours to indicate the tape number, yielding 1 to 23 unique reel numbers per shooting day.

Time Code is recorded simultaneously in the video signal as VITC (Vertical Interval Time Code) and on the time code track as LTC (Longitudinal Time Code).

In addition, many productions will record a separate Sound Department Time Code as an audio signal on Audio Channel 2.

One key workflow choice is whether the Camera Time Code will be generated internally or defined by an external source. If your production has opted for external time code, you should consult the post-production supervisor for a detailed description of how they want to implement this, as there are a host of different options. Some of the choices include what kind of external TC generators will be used, whether to feed TC or LTC, whether to have User Bits, whether to Gen Lock or not, etc...

In **RECORD RUN** mode, the TC generator only increments while you are recording. This yields continuous TC on the finished videotape. In **FREE RUN** the TC generator usually acts as a clock, using the "time of day". This creates discontinuous TC on the videotape, but is sometimes used to synchronize multiple cameras.

We will focus here on the customary way of working with internal TC, which involves working in the RECORD RUN mode and incrementing the Time Code hour for every new tape.

If your production requires external Time Code, consult your post-Production supervisor about connections to an external TC generator and their desired TC settings.

18.2 To change PRESET TC hour before starting new tape.

1. **Push** EJECT to open door and remove old tape. Do not put in new tape just yet.
2. **Push** black rectangular **TC** menu button on the left-hand side of SRWC panel
3. A new **TC Setup** screen appears. If **TCG MODE** reads **PRST**, go to step 4

If TCG MODE reads RGN

- A. **Turn** the SELECT/ENTER thumbwheel on upper right to position white rectangle around TCG MODE
- B. **Push** thumbwheel. A new window, labeled **TCG Mode**, appears at bottom right
- C. **Turn** thumbwheel to position white rectangle around **Preset**.
- D. **Push** thumbwheel to confirm Preset. The window will disappear and the **TCG MODE** will now read **PRST**

4. **Turn** thumbwheel to position white rectangle around **TIMER PRESET** (3rd line down)

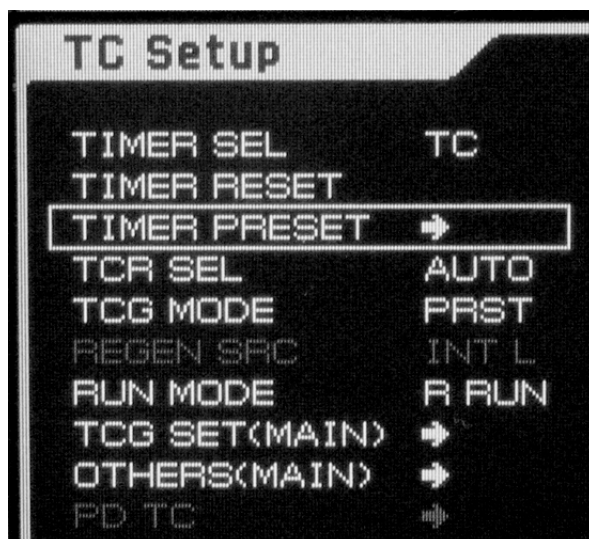

5. **Push** thumbwheel. A new window, labeled **Timer Preset**, appears in upper right.

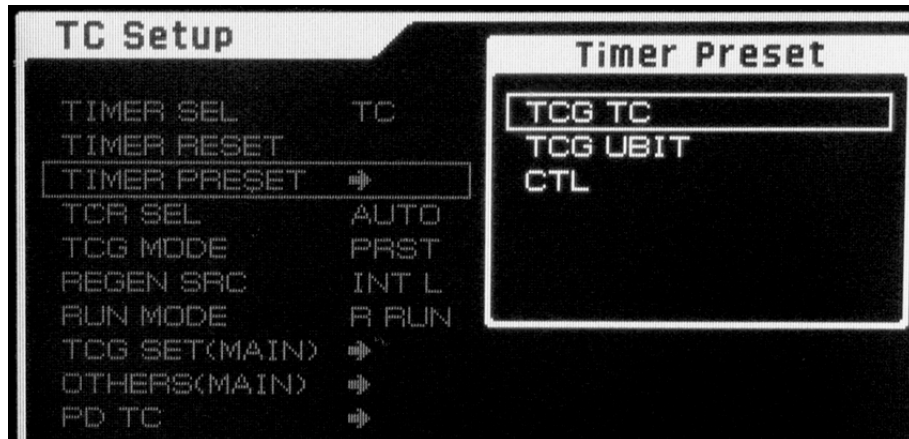

6. Make sure white rectangle is around **TCG TC**

7. **Push** thumbwheel. A new window, labeled **TCG TC** (Time Code Generator Time Code), appears on bottom right. All 8 numbers are highlighted.

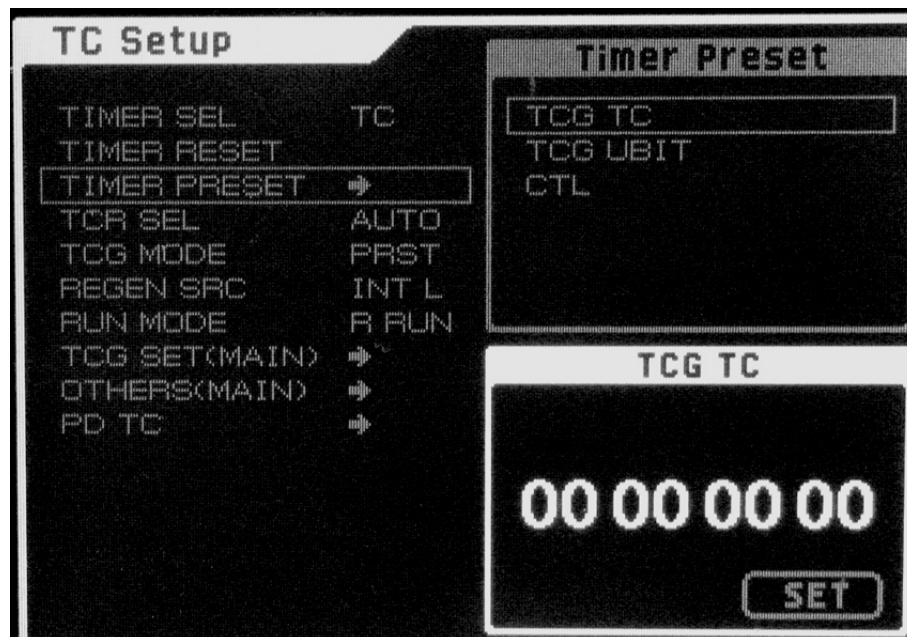

The 8 digits are 4 pairs of numbers that stand for hours minutes seconds and frames.

8. **Turn** thumbwheel to position white **triangle cursor** above the hour (first or second digit) that you want to change.

9. **Push** thumbwheel, only one digit is now highlighted



10. **Turn** thumbwheel to increment hour

11. **Push** thumbwheel to confirm, all the digits are highlighted

12. **Turn** thumbwheel until **SET** is highlighted



13. **Push** thumbwheel to confirm new TC value. The bottom window disappears, and the upper right window is highlighted

14. **Push** rectangular **HOME** button on left to exit to main screen

15. **Insert** new tape, you're ready to record. The first recording will start with the PRESET Time Code value you have set.

X

If you get a STANDBY error when you try to SET, it will be necessary to turn STANDBY OFF by keeping FUNC pushed down while you push STOP. See 7.6

(This error can only happen if you have a tape in)

18.3 Recommended Time Code settings (Internal TC)

Panavision recommends the following VTR Time Code menu settings when shooting with Internal Time Code. You should consult your post-production house about these settings.

Assuming Internal Time Code

TIME CODE	TIMER SEL	TC	
	TIMER RESET		
	TIMER PRESET	TCG TC	
	TCR SEL	AUTO	
	TCG MODE	PRST	
	<i>REGEN SRC</i>	<i>INT L</i>	
	RUN MODE	R RUN	
	TCG SET(MAIN)	DF/NDF UBG SRC 12H/24H	Non Drop Frame TCG Source 24 H
	Others(Main)	TC OUT RT REC RT SET LTC Delay VITC Delay	Auto VITC 0 0
	PD TC		

A brief explanation of the terms appearing in the Time Code menus:

TIMER SEL = Type of time data displayed on HOME menu. There are 3 possibilities:

TC = Time Code, the Panavision default

UBIT = Time code User Bits.

CTL = ConTrol track (arbitrary frame count number that is reset every time power is turned off or tape is ejected)

TCG = Time Code Generator

TCR = Time Code Reader

TCG MODE PRST = TCG in Preset mode. TC recording will begin with the Preset value (as opposed to Regen or Real Time)

REGEN SRC = Source for Regenerated TC. In Regen mode TC recording continues the TC previously recorded on preceding take.

R RUN = Record Run mode. In Record Run TC only increments during recording. The result is continuous TC during playback. (The alternative is Real Time TC which records the "time of day").

UBG = User Bit Generator

RT = Real Time

LTC = Longitudinal Time Code

VITC = Vertical Interval Time Code

Note: some productions prefer to use Time Code PRST to lay down the first take of the tape, and then switch to REGEN for all the other takes. As always, consult your post-production supervisor about Time Code settings

If your production requires external Time Code, consult your post-Production supervisor about connections to an external TC generator and their desired TC settings.

19. VTR Menu Audio Settings

19.1 Basic Audio Settings

19.2 A quick check of HOME screen

19.3 To set audio Channels to ANALog

19.4 To ajust audio recording levels

19.5 To change CH1 or CH2 recording from UNI to VAR

19.6 To set audio playback level to UNI

19.7 To adjust 2 channels at once

19.8 To adjust Earphone Channels

19.9 VTR AUDIO Menu Recommended settings

19.1 Basic Audio Settings

Following are the basic adjustments you may want to make to the Audio settings on the SRW-1 VTR in consultation with the Production Sound Mixer and his or her crew:

- Set audio Channels 1 & 2 to **ANALog**

Typically an ANALog “scratch track” is recorded on CHannel 1 of the VTR, and ANALog LTC Time Code is recorded on CH2.

- Adjust audio recording levels.

CH1 Audio Record level is usually set using a tone feed from the sound department. The level is usually set at -20 db, but consult the sound department for their requirements.

- Change recording from **UNIty** to **VARIable**

If CH1 or CH2 recording are set to UNIty, you will need to change to VARIable.

- Set Audio playback level to **UNIty**

Playback levels are usually set at UNIty, rather than VARIable.

- Adjust 2 CHannels at once

When recording stereo audio, you can adjust 2 (or more) CHannels simultaneously. This is an unusual case.

- Allocate EARPHONE **L**eft and **R**ight audio signals

The EARPHONE plug is the only audio output from the SRW-1. When using this output, you will need to allocate the Left and Right channels. Typically CH1 will go to Left and CH2 to Right.

Panavision recommends repeating the above settings when connecting the SRW-1 to the SRPC See chapter 21

19.2 A quick check of HOME screen

A quick check of the top left corner of the VTR HOME screen will confirm the Analog and Earphone settings.

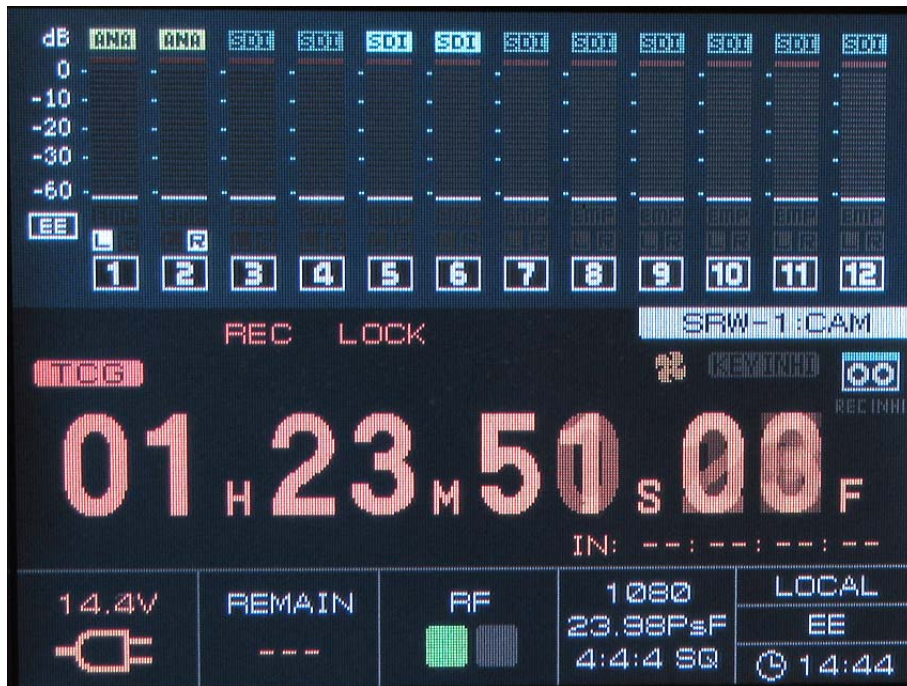

The HOME screen always indicates, for each of the 12 channels:



Audio input type:

ANAlog (green)

SDI (blue)

EARPHONE Allocation:

Left

Right

Left & **R**ight

None

The Panavision defaults are as depicted above:

CH1 and CH2 ANAlog input

EARPHONE CH1 Left and CH2 Right

19.3 To set audio Channels to ANAlog

1. **Push** the AUDIO menu button on the left side of the panel, an **Audio Setup** menu will appear.
2. The first item of the list, **INPUT SEL** should be selected, (with a white rectangle around it). Push the SELECT/ENTER thumbwheel.
3. A new small window labeled **Input Select** will appear in the upper right, with a list of Audio tracks and inputs:

TRACK1 ????

...

TRACK12 SDI12

4. **Turn** the SELECT/ENTER thumbwheel until **TRACK1** is selected by white rectangle
 5. **Push** the thumbwheel, a new window, labeled **Track 1**, will appear in the lower right, with a list of possible inputs to Track 1:
- SDI CH1
- ...
- Analog CH1
- Analog CH2
6. **Turn** thumbwheel until Analog CH1 is selected by white rectangle
 7. **Push** thumbwheel to confirm choice, the lower right window will disappear, and the upper right Input Select window will reflect the new attribution:
- TRACK1 ANA1
8. **Push** HOME button on left to exit to main screen.

19.4 To adjust audio recording levels

1. **Push** the LINE-MIC switch on the SRW-1 to the appropriate position. See [6.3](#)
2. **Push** the AUDIO menu button on the left side of the panel, an Audio Setup menu will appear.
3. **Turn** the SELECT/ENTER thumbwheel on the right of the panel to navigate down the menu, until REC LEVEL is selected, as indicated by the white rectangle around it.

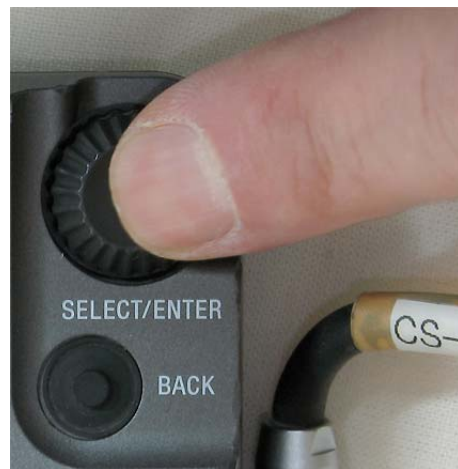

4. **Push** the SELECT/ENTER thumbwheel to confirm the REC LEVEL choice
5. The screen will change. In the upper left corner, a white triangular cursor will point down at CH1.
6. **Push** thumbwheel to highlight CH1 and its four digit number value below the bar graph. This is a toggle. You can only change settings of a channel when it is highlighted.

Note that more than 1 Channel can be highlighted. To toggle a Channel highlight on or off, position white triangle above the Channel bar graph and Press thumbwheel.

If CH1 reads UNI, you will need to toggle to VAR, see [19.5](#)





7. Turn the big ADJUST wheel to change the audio level.



Turn ADJUST wheel until... level reaches 20db or below
(LTC time code levels should be kept below 20 db)

8. As you ADJUST the level, the bar graph will rise and the highlighted number below will also change. The range is in Hexadecimal numbers which go from 0 to 9 then A through F (F is 16). The four digit scale goes up from 0000 to FFFF.





9. **Push** the thumbwheel to confirm your adjustment: the CH1 level below will be grayed out, indicating that CH1 settings cannot be changed.



10. **Turn** the thumbwheel to move the white triangular cursor above Channel 2. You can now repeat steps 5-7 to highlight CH2 and adjust its level, usually LTC time code, at -20 dB.

19.5 To change CH1 or CH2 recording from UNI to VAR

1. **Push** the **AUDIO** menu button on the left side of the panel, the Audio Setup menu will appear.
2. **Turn** the SELECT/ENTER thumbwheel on the right of the panel to navigate down the menu, until **REC LEVEL** is selected, as indicated by the white rectangle around it.
3. **Push** the SELECT/ENTER thumbwheel to confirm the REC LEVEL choice
4. The Rec Level screen will appear. In the upper left corner of the new screen, a white triangular cursor will appear above CH1.
5. **Push** SELECT/ENTER thumbwheel until **CH1 UNI** is highlighted, indicating that it can be changed. This is a toggle.
6. **Turn** SELECT/ENTER thumbwheel counter-clockwise until **UNI /VAR** box at the bottom right is highlighted
6. **Push** SELECT/ENTER thumbwheel to toggle from **UNI** to **VAR**
7. **Push** **HOME** button to exit.

19.6 To set audio playback level to UNI

Panavision recommends setting playback levels for CH1 and CH2 to UNItY, unless the Sound Department requests a VARiable setting.

1. **Push** the AUDIO menu button on the left side of the panel, an Audio Setup menu will appear.
2. **Turn** the SELECT/ENTER thumbwheel on the right of the panel to navigate down the menu, until PB LEVEL is selected, as indicated by the white rectangle around it.
3. **Push** the SELECT/ENTER thumbwheel to confirm the PB LEVEL choice
4. The screen will change. You are interested in the upper left corner of the new screen. A white triangular cursor will point down at CH1. If the display reads CH1 UNI, you're done; otherwise:
5. **Push** thumbwheel to highlight CH1 value
6. **Turn** thumbwheel counter-clockwise until UNI/VAR is highlighted.
7. **Push** thumbwheel to toggle CH1 from a variable 4-digit number to UNItY.
8. Once the display reads CH1 UNI, **Turn** thumbwheel clockwise until white triangle cursor is above CH2. Repeat steps 5-7.
9. When both CH1 and CH2 display UNI, **Push** HOME button to exit.



Variable playback level is best adjusted when videocassette is in playback mode.

19.7 To adjust 2 channels at once

You can adjust the level or the UNI/VAR setting of 2 or more channels at once, for example for stereo recording. When you first enter the Rec Level screen, CH1 is highlighted. To add channel 2:

1. **Turn** thumbwheel so that top white triangle cursor is pointing at CH2
2. **Push** thumbwheel so that CH2 is highlighted

With both channels highlighted, any setting you change will apply to both channels:

ADJUST will change levels of both channels

RESET will reset both channels

UNI/VAR will toggle both channels



*If 2 channels are highlighted and you only want to adjust 1 channel, position triangular cursor above the channel you don't want to adjust, then **Press** thumbwheel to turn highlight off.*

19.8 To adjust Earphone Channels

Some audio engineers will use the EARPHONE stereo mini output to monitor the audio of the SRW-1 VTR. In this case you may need to allocate the audio channels to the required Left or Right channel. To do so:

1. **Push** the AUDIO menu button on the left side of the panel, the Audio Setup menu will appear.
2. **Turn** the SELECT/ENTER thumbwheel on the right of the panel to navigate down the menu, until **PHONE SEL** is selected, with a white rectangle around it.
3. The **Phone Select** screen appears. The white triangle cursor will be on the upper left, pointing down at CH1.
4. **Push** thumbwheel repeatedly to toggle through the following settings:
 - L (blue) – CH1 is routed to Left
 - R (red) – CH1 is routed to Right
 - L R (blue and red) – CH1 is routed to Left and Right
 - Grayed out – CH1 is not routed to Left or Right
5. **Turn** thumbwheel to position white triangle cursor above CH2.
6. **Push** thumbwheel to set CH2 allocation
7. **Push** HOME to exit menu



Use the EARPHONE LEVEL knob below the EARPHONE plug to set the playback volume level. See [6.3](#)

During recording, the EARPHONE output is EtoE only, it is not from a confidence head (off tape).

19.9 VTR AUDIO Menu Recommended settings

Panavision recommends the following Audio menu settings.

AUDIO	Input Sel	Track1 Track 2	Analog CH1 Analog CH2
	Phone SEL	CH 1 CH 2	Left Right
	Mix Mode	RMS	
	Rec Level	CH1 CH2	VAR VAR
	PB Level	CH1 CH2	UNI UNI
	Meter Type	Full Peak	
	Peak Hold	On	
	Beep (Phone)	Alarm Warn	Off Off
	Input Delay	No Delay	

You should consult the Sound Department, and the Production Mixer about these settings.

20. About Variable Speed

20.1 Variable Speed 1 to 50 fps

20.2 Use 422 from 30 to 50 fps

20.3 The S (selectable) ranges of speed

20.4 A different cassette for each different format

20.5 Target Playback frame rate

20.6 Using compatible Target fps and Selectable ranges

20.7 Using VTR DEFault FPS Format with 23.98 & 24

20.8 Playback of variable speed

20.9 The 422/444 mismatch issue

20.10 To set System Menu FPS Format

20.11 To turn Standby OFF

**20.12 To shoot variable speed with VTR mounted on
Genesis**

20.13 <SELECT FPS> Viewfinder Menu page P14

20.14 In variable speed, the SRW-1 records in 2 steps

At present, the SRW-1 can only record Selectable variable speed correctly if it is mounted on the Genesis camera. Consult your Panavision technical representative for more information.

20.1 Variable Speed 1 to 50 fps

The Genesis/SRW-1 system has the capability of recording and playing back at variable speeds: from 1 to 50 frames per second in increments of 1 fps. The effect of variable speed when played back at the fixed frame rate of your project is identical to that of film: recordings at slow speeds will speed up motion and recordings at fast speeds will yield slow motion.

20.2 Use 422 from 30 to 50 fps

Panavision recommends recording at 4:4:4 (or 444) whenever possible, rather than 4:2:2 (or 422). However, when shooting above 29.97 frames per second, there is too much information for the VTR to record at 444, so the SRW-1 must be switched to 422.

20.3 The S (selectable) ranges of variable speed

Before recording variable speed with the Genesis system you must select one of the following **Selectable** ranges of variable speed, each range has the S prefix:

S29.97PsF Range of 1 to 30 frames per second

S30PsF Range of 1 to 30 frames per second

S59.94P Range of 1 to 50 frames per second (422 only)

S60P Range of 1 to 50 frames per second (422 only)

S29.97 and S30 (like S59.94 and S60) offer the same range of frame rates. The difference between them is their time code format. For example, the S30 range is not compatible with 23.98 fps, so there could be playback errors of footage recorded at S30 at played back at 23.98.

When the SRW-1 VTR is attached to the Genesis, there is no need to change the Selectable Range of frame rates on the VTR, as it will automatically follow the camera setting.

20.4 A different cassette for each different format

Panavision recommends changing the video cassette when you change formats. We recommend having a different cassette for your fixed speed and your 2 Selectable ranges. For example, when working in 23.98 you should use 3 different tapes for 23.98, S29.97 and S59.94 footage.

20.5 Target Playback frame rate

When recording variable speed, the SRW-1 VTR assumes a given playback frame rate, its "target" frame rate. The target frame rate is indicated in parentheses on the SYS line of the 3 line display

*A mismatch at the time of recording between the **Selectable range** (e.g. S59.94 or S60) and the **Target playback rate** (e.g. 23.98 or 24) and can lead to errors in subsequent playback (e.g. Time Code interruptions or loss of LOCK).*

20.6 Using compatible Target fps and Selectable ranges

To avoid future playback problems, you should ensure that the Selectable range format you use to record with is compatible with your desired Target Playback fps, which is your project's frame rate.

Target Playback format	Compatible S electable ranges
23.98P	S29.97 or S59.94
24P	S30 or S60
25P	S30 or S60
29.97P	S29.97 or S59.94

The rule of thumb is: if your project frame rate is a whole number, use a whole number S range. If your project frame rate is a number with a decimal point, use a S number with a decimal point.

20.7 Using VTR DEFault FPS Format with 23.98 & 24 fps

If your project is shooting 23.98 or 24, Panavision recommends setting the SRW-1 **FPS FORMAT** to **DEFault** (see 20.10 for how to do this). When the VTR is mounted on the Genesis, this setting automatically ensures that there will be no mismatch between the **Selectable** range and your Target frame rate.

With the **FPS FORMAT DEFault** setting, the VTR will automatically switch its target playback to 23.98 fps if you change the format to S29.97 or S59.94, and it will switch to a target playback of 24 fps if you go to S30 or S60.

Do not use the VTR DEFault if

- 1. the SRW-1 is separated from the Genesis camera body,*
- 2. or your project frame rate is 25 or 29.97 fps.*

20.8 Playback of variable speed

To check the motion effect of variable speed, you should change the format back to your fixed speed. For example to see the slow motion effect of footage shot with the S59.94 format, you must change the format back to 23.98.

20.9 The 422/444 mismatch issue

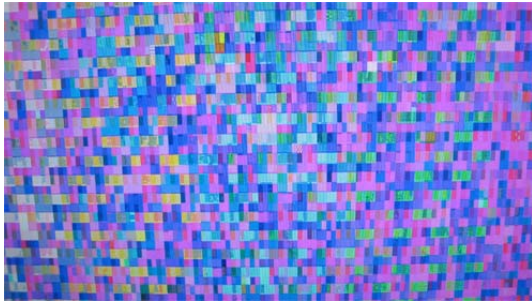

422 footage cannot be played back with a 444 format, or vice versa. If you try this, the image will be colored noise.

Therefore if you take footage shot in S59.94 or S60 422 and want to playback to check the slow motion effect with the VTR format at a fixed speed (like 23.98 or 24), you must leave the color sampling at 422.

422/444 mismatch is not an issue with footage shot in S29.97 or S30 at 444, because recording and playback are both at 444.

Recording format	Playback format to check motion effect
444 S29.97	444 23.98
444 S30	444 24 or 444 25
422 S59.94	422 23.98
422 S60	422 24 or 422 25

Panavision recommends that you verify the VTR FPS format after doing a check playback. Switching back and forth between color sampling modes and formats can leave this setting in an undesired state

20.10 To set System Menu FPS Format

1. **Push** SYSTEM rectangular button on left.
2. A new screen appears, labeled System Setup.

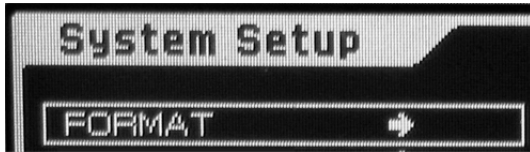

A white rectangle is around the top item FORMAT. **Push** the SELECT/ENTER thumbwheel.

3. A window, labeled **Signal Format**, appears on upper right.
4. **Turn** SELECT/ENTER thumbwheel until white rectangle surrounds

FPS FORMAT

5. **Push** thumbwheel.

6. A window, labeled **Select FPS Format**, appears on lower right.

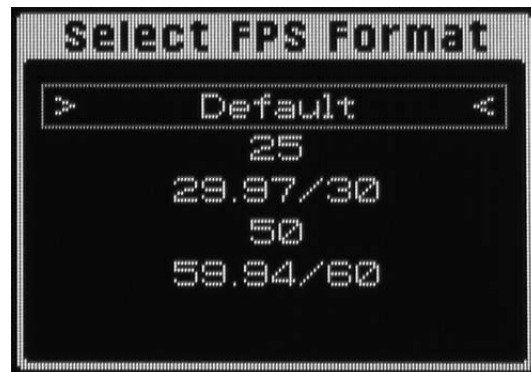

7. **Turn** thumbwheel until white rectangle is around your desired format which is **Default** if you are shooting in 23.98 or 24

8. **Push** thumbwheel. The lower right window disappears, returning you to **Signal**

Format

9. **Turn** thumbwheel until white rectangle surrounds **SET**

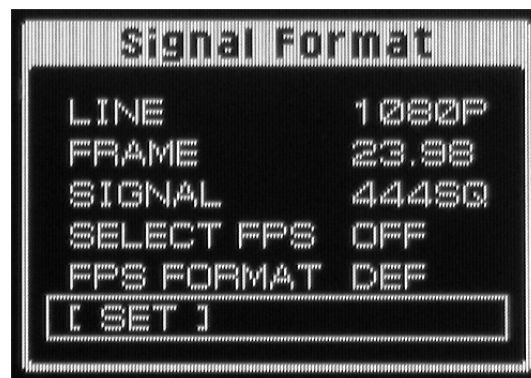

10. **Push** thumbwheel.

11. A confirmation window appears. **Push** thumbwheel to confirm new Format

12. The SRW-1 VTR will reboot with new format.

If you are shooting at other fixed speeds than 23.98 or 24, you should not use set FPS FORMAT to DEFault, but rather choose either 29.97/30 or 59.94/60 depending on how fast you need to go.

20.11 To turn Standby OFF

When you push SET to change FPS FORMAT you may get an error window stating **Can't Change while Standby is ON**

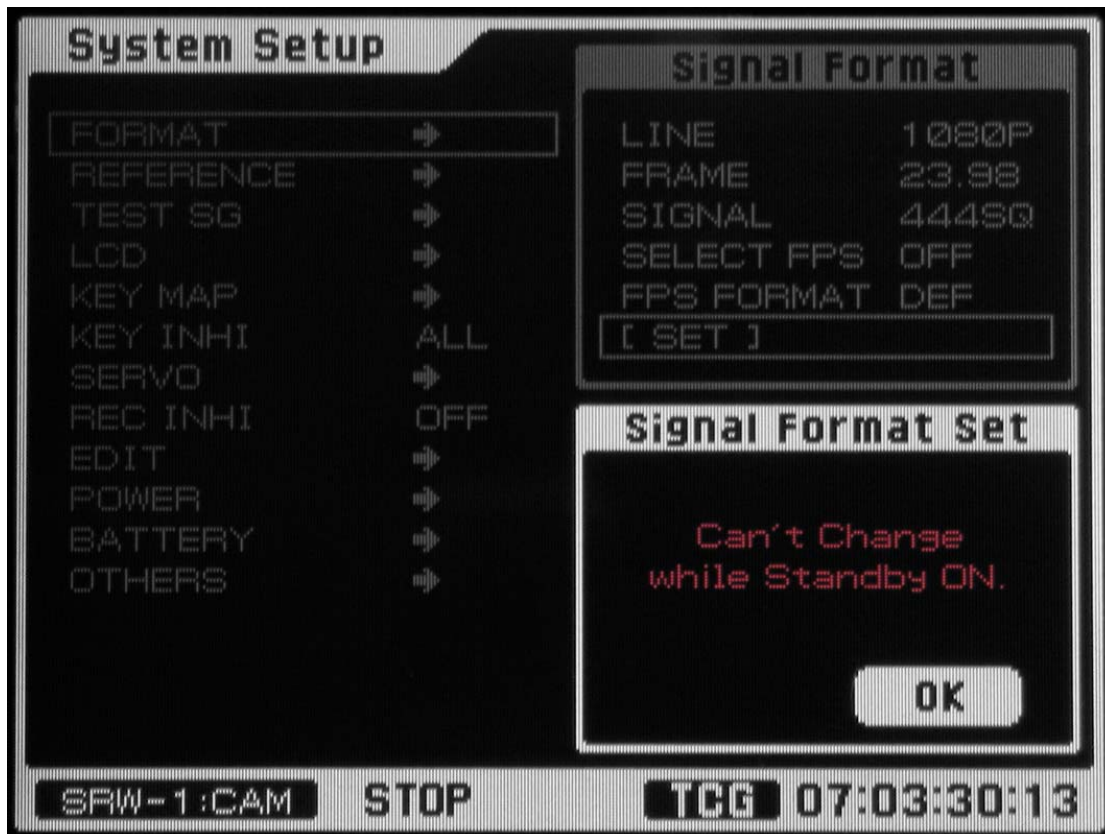

1. **Push** thumbwheel to close Error message
2. Keep FUNC **held down** and **push** STOP. This puts VTR in STANDBY OFF mode.
STBY OFF will appear at bottom of screen.



20.12 To shoot variable speed with VTR mounted on Genesis

1. **Push** EJECT & take out video cassette. Panavision recommends that you use a different cassette for fixed speed and for each of your 2 Selectable speed ranges. (e.g. 23.98, S29.97 and S59.94).

Do not put in the new cassette yet.



2. **Click UP** vf/lcd switch on camera repeatedly to access Viewfinder menus
3. **Turn & click** thumbwheel on camera to navigate to page U1 in USER menu (or page M6 in the Maintenance menu)

4. **Turn** thumbwheel to position arrow on the NEXT line pointing at 444 or 422. Push thumbwheel to turn cursor into question mark
5. **Turn and Push** thumbwheel to select sampling format:
 - a) 444 if you will be shooting variable speed of 30 fps or less
 - b) 422 if you will be shooting variable speed above 30 fps.
6. **Turn** thumbwheel to position arrow pointing at the format on the NEXT line.

Push thumbwheel to turn cursor into question mark

```

<MULTI FORMAT>      M6  TOP
CURRENT : 444      23.98PsF
NEXT    : 444     ?S29.97PsF
SET FORMAT
  23.98PsF      24PsF
                25PsF
  29.97PsF      30PsF
                50P
  S29.97PsF     S30PsF
  S59.94P       S60
  
```



7. **Turn and Push** thumbwheel to desired Selectable fps range:

a) If you are shooting 23.98, or 29.97 select:

a1) S59.94 if you will be shooting above 30 fps

a2) S29.97 if you will be shooting 30 fps or less

b) If you are shooting anything else, select:

b1) S60 if you will be shooting above 30 fps

b1) S30 if you will be shooting 30 fps or less

8. **Turn** thumbwheel to position arrow in front of SET FORMAT

9. **Push** thumbwheel to confirm new format. The SRW-1 will reboot.

Seconds later, the camera and VTR will automatically change formats.

→SET FORMAT

After you SET FORMAT, the SRW-1 VTR will Reboot...

The return of the HOME screen indicates the VTR is ready.

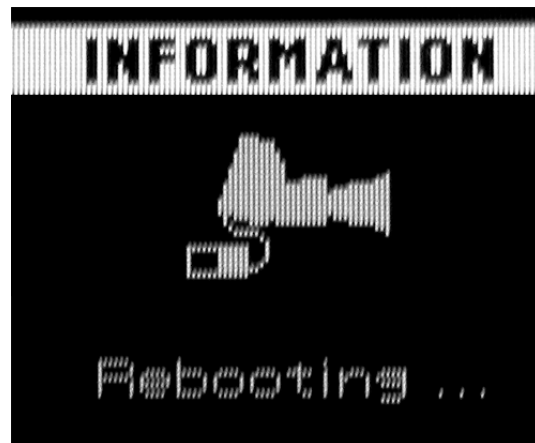

10. **Click UP** vf/lcd switch once to leave Viewfinder menu

You will now turn your attention to the Camera LCD menu

11. **Click DOWN** vf/lcd menu down to activate LCD menu



12. A question mark **? cursor** will appear indicating LCD menu is

active. **Turn** thumbwheel until FPS is on top row of LCD Menu Panel



13. **Push** thumbwheel to position **? cursor** on bottom row

14. **Turn** thumbwheel to change fps setting to desired one



15. **Click DOWN** vf/lcd switch once to exit LCD menu

16. The LCD will display the Selectable Range and the FPS in that range that you just selected

17. Put in the cassette that corresponds to the Selectable speed range you will be shooting with.

18. Set Time Code (new tape) or Push the REC REVIEW assign switch (used tape) and you're ready to shoot.

Note that you can change the FPS to another variable speed in the range you are working in, without having to go back to the M6 menu.

Once you are finished shooting variable speed, use steps 1-9 of the same procedure to go back to your fixed speed. Or see [14.7](#)

You must disconnect external Time Code sources when recording at Selectable Frame Rates. If you do not you may faulty frames in your footage.

Note that, just as with film shooting, you should be wary of HMI flicker or light cycling when shooting at variable speeds.

At present, the SRW-1 cannot record variable speed correctly when it is not mounted on the Genesis camera. Contact your Panavision technical representative for details.

20.13 <SELECT FPS> Viewfinder Menu page P14

This VF menu page has important settings that define the look of variable speed recordings

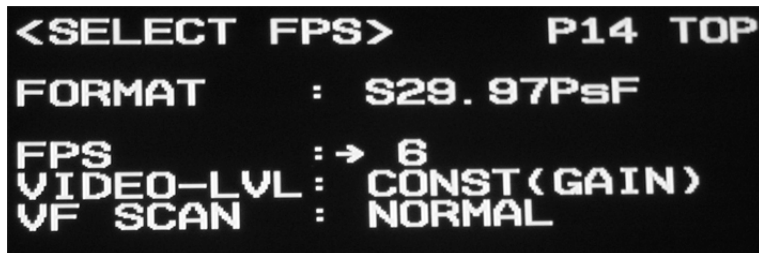

FORMAT indicates the current Selectable speed range

FPS indicates the current FPS. This setting is more easily accessed via the camera LCD menu.

VIDEO-LVL

CONST(GAIN) will vary Shutter to keep exposure constant at different FPS rates

CONST(SHUT) will vary Gain to keep exposure constant at different FPS rates

ACCUM will change exposure with FPS. Smaller FPS numbers will yield more exposure than higher ones.

VF SCAN

NORMAL will keep image from flickering at FPS rate

NON-ACCUM will flicker the image at the FPS rate

Panavision recommends setting

VIDEO-LVL CONST(GAIN) and VF SCAN NORMAL

unless you are seeking an unusual effect

20.14 In variable speed, the SRW-1 records in 2 steps

1. Frames are recorded into a “Picture Cache” MEMory, while the VTR is paused in record standby.
2. When the Picture Cache is almost full, the VTR goes into a fixed frame rate and records a “spurt” of frames from the Cache, then pauses. The emptied Cache then fills up anew, and so on.

During Variable Speed recording you can see these 2 steps by keeping the FUNC button down and pushing HOME. The bottom of the screen will display a bar graph indicating the MEMory status:

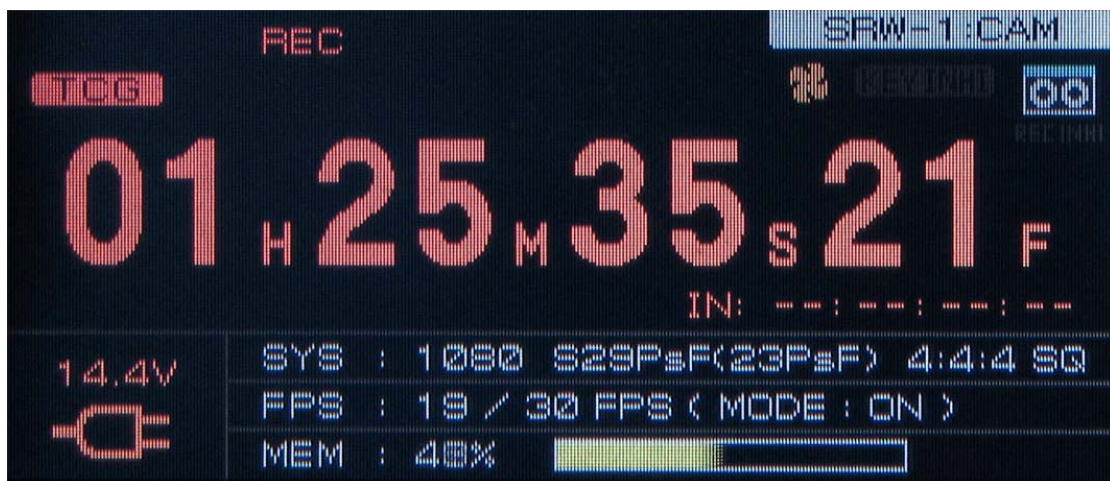

A growing yellowish bar indicates the **MEM**ory filling up, while the VTR is paused, as indicated by a frozen TC number

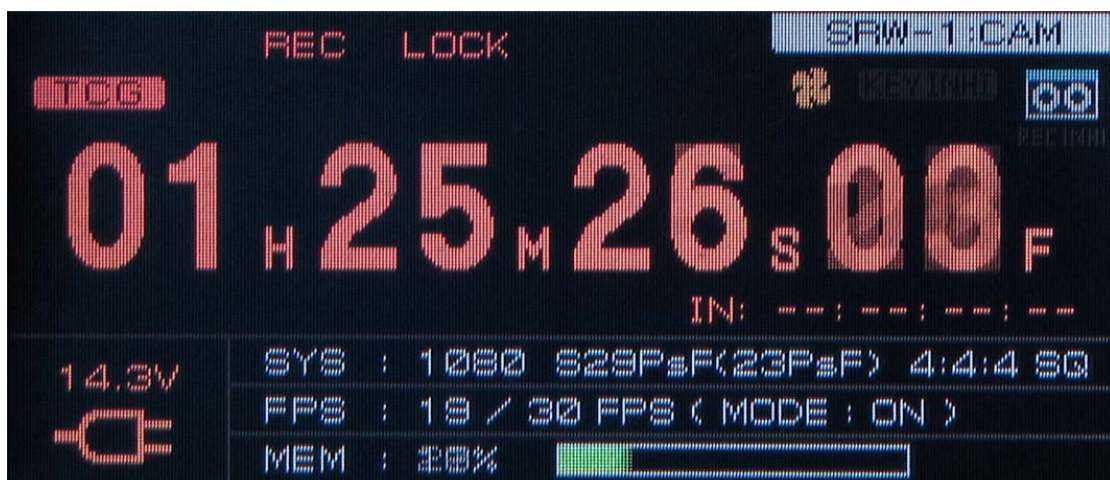

A shrinking greenish bar indicates that the VTR is recording a spurt of frames from the MEMory

21. Camera Separated from VTR

21.1 Dual Link HD SDI

21.2 To mount SRW-1 on top of Toaster (SRPC)

21.3 To unmount SRW-1 from Toaster (SRPC)

21.4 To power the SRPC and SRW-1

21.5 Use 2 BNC cables

21.6 To connect Genesis Dual-Link video to the SRPC

21.7 Audio connections and settings

21.8 SRW-1 and Genesis formats

21.9 SRW-1 System Signal Format settings

21.10 To change SRW-1 format

21.12 Using Format List to change SRW-1 format

21.12 The SRPC connector panel

At present, the SRW-1 can only record Selectable variable speed correctly when it is mounted on the Genesis camera. Consult your Panavision technical representative for more information.

21.1 Dual Link HD SDI

When there is a need for a lighter or smaller camera system, the SRW-1 VTR is separated from the Genesis body and mounted on top of the SRPC "Toaster" unit. The Genesis video output is connected to the SRPC video input, usually via 2 **CBLE-BNCH** Canare or equivalent cables in a configuration called "Dual Link" HD-SDI



21.2 To mount SRW-1 on top of Toaster (SRPC)

1. Locate the big black latch on SRPC above the connector panel
2. **Swing** the big black latch away from SRPC body
3. **Position** VTR on top of SRPC, and settle it in. The yellow dash on the SRW-1 should align with the red dash on the SRPC
4. **Swing** latch towards body. It should click in, securing the SRW-1 to the SRPC



5. **Turn** the lock lever below the yellow LOCK text clockwise 90 degrees, until lever is pointing at 9 o'clock.

X

21.3 To unmount SRW-1 from Toaster (SRPC)

1. **Turn** lock lever 90 degrees counter-clockwise. Lever should end up below yellow "LOCK" lettering, pointing at 3 o'clock.



2. **Pull** circular tab out to unlock SRW-1 and
3. **Swing** black latch on SRPC out away from body. This should begin to push VTR out from the SRW-1.
4. **Lift** VTR up and away.

X

21.4 To power the SRPC and SRW-1

There are 2 ways to power the SRPC:



A. Connect the AC adaptor to the **DC IN** 4-pin male XLR connector on lower left of the SRPC connector panel.

B. Slide a Sony BP-GL95/IL75 battery on the side of the SRPC opposite from the connector panel.



The SRPC battery connection is covered by a thin panel that can be slid out by pushing down on the button labeled with a white rectangle.

You must turn 2 POWER switches ON to operate the VTR:

- POWER on the SRW-1 connector panel
- POWER on the SRPC connector panel

You can turn both units off using the POWER switch on the SRPC

Panavision recommends you leave EXT DC SELECT on AUTO. The EXT positions forces the SRPC to always use power from the DC IN, even when this voltage is low or off.

21.5 Use 2 BNC cables

You can record the Genesis on a separate VTR using 1 or 2 BNC cables. Because of the increased data flow, you need the 2 cable configuration to record "Dual Link" HD SDI 444 or to record 422 at S59.94 or S60. With one cable you can only record 422 from the HD SDI output of the Genesis.

Panavision strongly recommends that you record 444 when the SRW-1 is separated from the Genesis. This entails a "Dual link" HD-SDI connection using 2 BNC cables
Be sure to use CBLE-BNCH Canare cables or equivalent.
Do not run lengths of more than 75 feet without an in-line amplifier.

21.6 To connect Genesis Dual-Link video to the SRPC

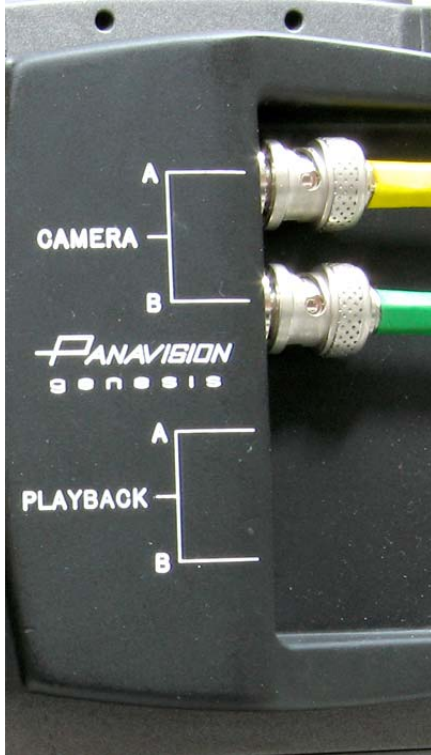

Dual Link
HD SDI
connection



1. **Mount** a GDPL BNC box on to the top or rear Genesis port.
2. **Connect** a BNC cable between CAMERA A on Genesis and HD SDI IN A on SRPC (maximum length of 75 feet)
3. **Connect** a BNC cable between CAMERA B on Genesis and HD SDI IN B on SRPC (maximum length of 75 feet)
4. **Push** VIDEO menu button on left of the SRWC panel of the SRW-1, and check that VIDEO I/O is set to VA INPUT SDI. Otherwise you will not get a signal (See [27.3](#))

X

21.7 Audio connections and settings

When the VTR is separated from camera, connect the CH1 and CH2 Audio to the SRW-1, exactly the same as when the VTR is mounted on the Genesis. *However, the audio settings will default to the SRPC settings. You should therefore repeat the settings described in [chapter 19](#) with the SRW-1 connected to the SRPC.*

21.8 SRW-1 and Genesis formats

When the SRW-1 is mounted on the Genesis camera, the VTR automatically follows the settings on the MULTI-FORMAT menu page of the camera Viewfinder menus.

When the SRW-1 is separated from the camera, you have to set formats twice:

1. On the SRW-1 with the VTR menu
2. On the Genesis camera with the Viewfinder menu.

Make sure that the Genesis camera and SRW-1 VTR have the same format settings. If the camera and VTR formats don't match you will jeopardize your recording and playback.

The SRPC and SRW-1 sometimes retain settings from previous couplings. So Panavision recommends that you SET the correct Signal Format even if it appears to already be correct as soon as the SRW-1 is mounted on to the SRPC, or as soon as the SRW-1 is mounted on the Genesis camera.

21.9 SRW-1 System Signal Format settings

In addition to the Audio and Time Code settings discussed in Chapter, you will need to verify and or set the following FORMAT parameters in the SRW-1 **System Setup** menu before recording:

- LINE

1080P is **P**rogressive, the usual setting for feature work

1080I is **I**nterlace a very unusual setting that may be required if you are inter-cutting with video cameras, say for TV studio work

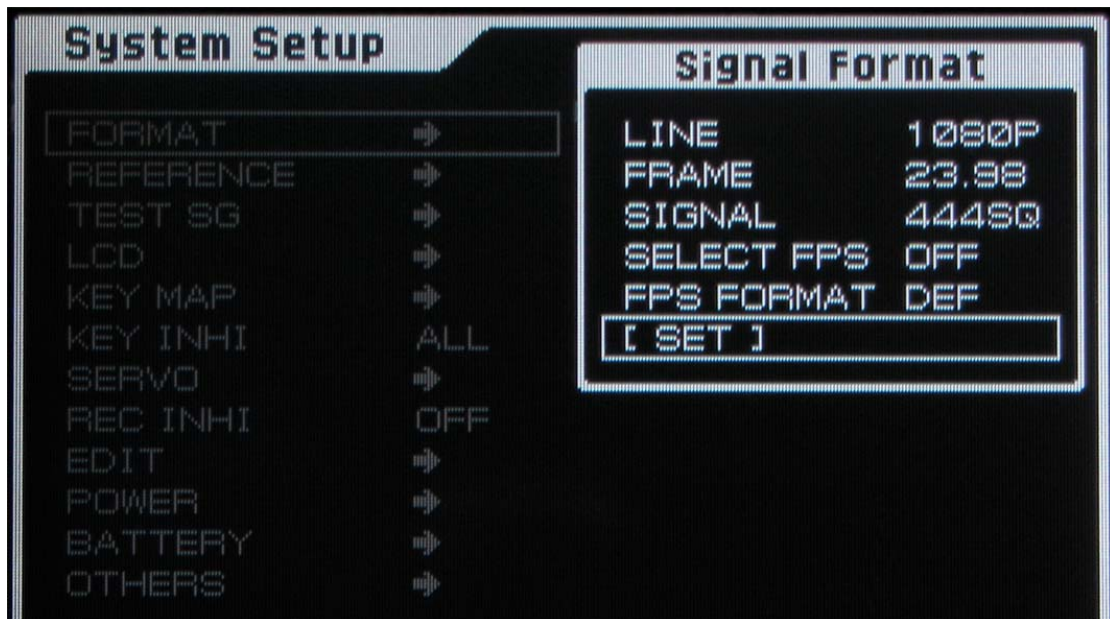

- **FRAME** your chosen frame rate

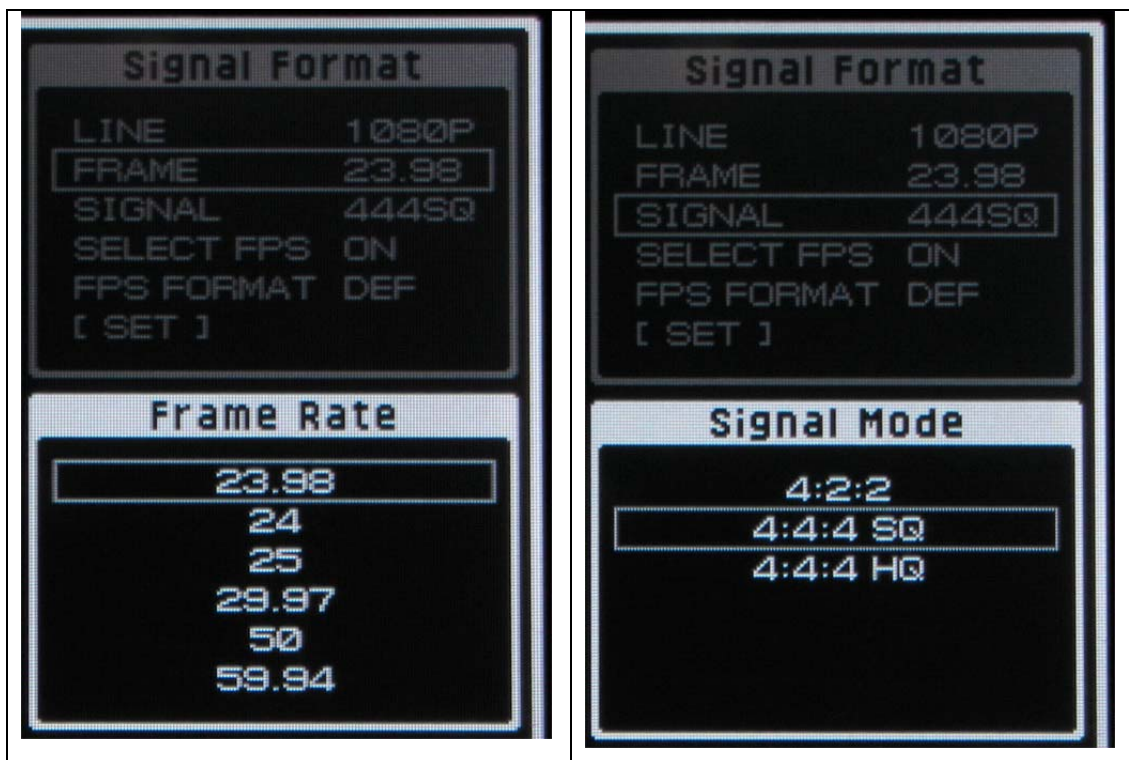

- **SIGNAL 444SQ or 422 Dual**

4:4:4 SQ for 23.98P, 24P, 25P, 29.97P fixed speeds

4:4:4 SQ for S29.97 and S30 Selectable speed ranges

4:2:2 Dual for S59.94 and S60 Selectable speed ranges

4:2:2 for Interlace speeds (59.94I, 60I)

Panavision recommends recording at 444 SQ, which is virtually indistinguishable in quality from 444 HQ recording, but uses half as much tape

- SELECT FPS

OFF for all fixed (non-S prefix) speeds

ON for S29.97, S30, S59.94 & S60 (Selectable speed ranges)

- FPS FORMAT

DEFault if your project fixed speed is 23.98 or 24

Otherwise select your project fixed speed:

25 fps

29.97/30 fps

50 fps

59.94/60 fps

21.10 To change SRW-1 format

1. **Push** SYSTEM button on left of SRW-1 control panel
2. In System Setup Menu, the first line, **FORMAT** should be highlighted: with a white rectangle around it
3. **Push** Thumbwheel on control panel to select **FORMAT**. A new window appears on upper right labeled **Signal Format**

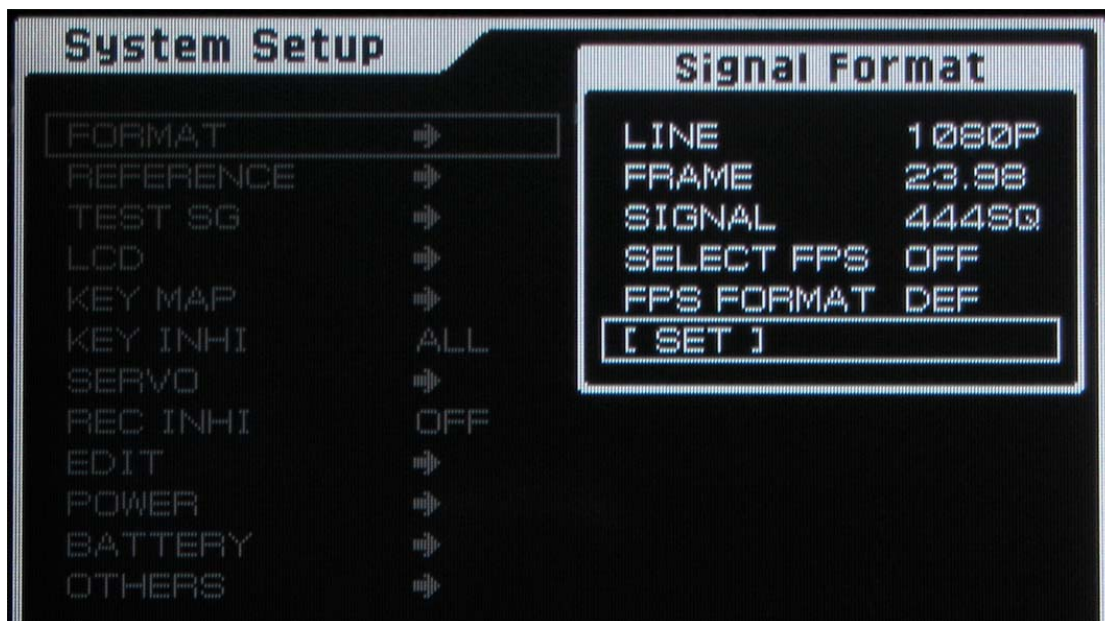

4. **Turn** and **Push** Thumbwheel to select the following Format settings:

LINE **1080P** unless you're shooting interlace

FRAME your project's fixed frame speed

SIGNAL

422 Dual for S59.94, S60 variable speed ranges

444SQ for 23.98, 24, 25, 29.97

SELECT FPS

OFF for 23.98, 24, 25, 29.97

ON for S29.97, S30, S59.94, S60

FPS FORMAT

DEFault for 23.98, 24

21.11 Using Format List to change SRW-1 format

The Format List in the System menu provides an alternative way to change the SRW-1 format. You can also use it just to see an overview of the possible formats.

To change SRW-1 format with Format List

1. **Push** SYSTEM button on left of SRW-1 control panel
2. The System Setup Menu appears, the first line, **FORMAT** should be highlighted:
3. **Turn** Thumbwheel on control panel to select **OTHERS** with a white rectangle around it.
4. **Push** Thumbwheel a new window appears on upper right
5. **Turn & push** Thumbwheel to select **Format List**. A new menu appears. Green checkmarks refer to Progressive formats, Yellow checks to Interlace formats

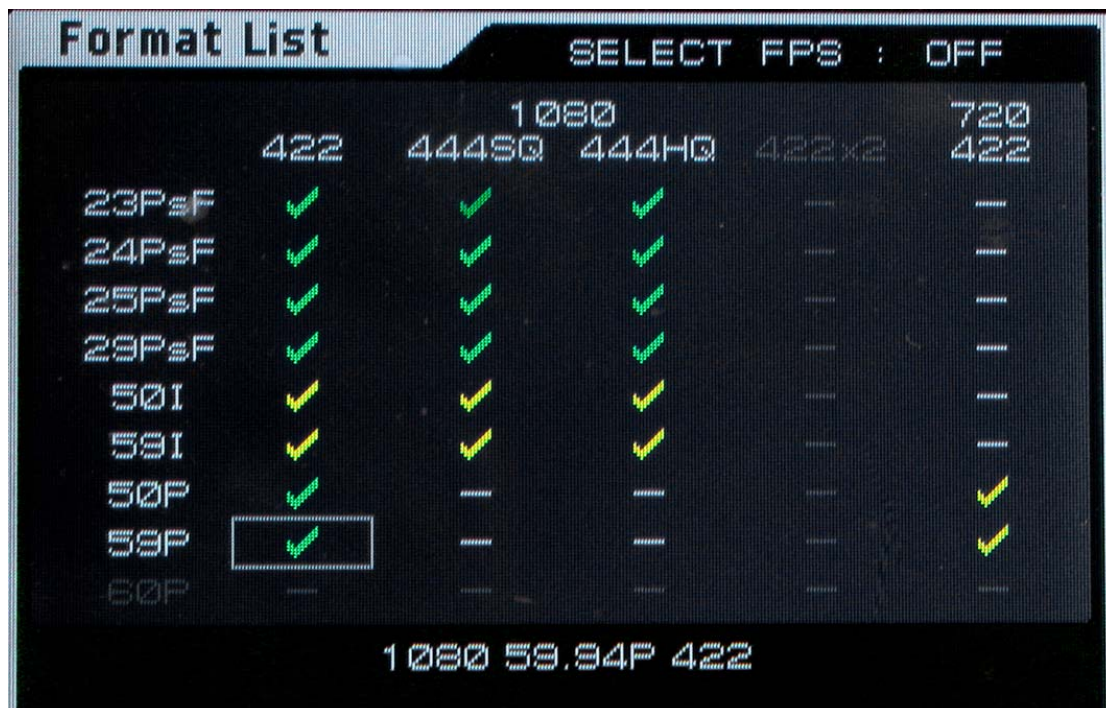

6. **Turn** Thumbwheel to select your desired format in the list. The chosen format details appear on the bottom of the screen.
7. **Push** Thumbwheel to restart the SRW-1 with your desired format

21.12 The SRPC connector panel



See [27.3](#) for **MONITOR OUT**put options.

22. Exposure

22.1 The Genesis 2K sweet spot

22.2 Exposure Index (ISO)

22.3 Lighting like you do with film

22. 4 Linear CCD versus non-linear Film

22.5 Analog CCD to 14 bit lin

22.6 14 bit lin = 16 k possible values per pixel

22.7 Panalog conversion of 14 bit lin to 10 bit log

22.8 Panalog allocates more to the dark values

22.9 What you see is not necessarily What you get

22.10 Panavision Genesis Display Processor

22.11 Light meters, Monitors and Waveforms

22.12 Panalog white, middle gray & black waveform

22.13 Over-exposure and Under-exposure

22.14 Exposure and Shutter

22.15 Exposure and GAIN

22.1 The Genesis 2K sweet spot

When designing the Genesis, Panavision did extensive research and testing which determined that a 1920 by 1080 pixel, 35mm-size CCD was the “sweet spot” for cinematography.

If the CCD had been designed with more pixels as a 4K sensor the camera would have had 2 stops less sensitivity, whereas a smaller 2/3 inch sensor would have had 1 stop less sensitivity, because of a smaller “fill factor”.

In addition, having a CCD that is approximately the same size as Super 35mm enables the cinematographer to seamlessly use film lenses without altering field of view or perspective, and without vignetting.

22.2 Exposure Index

Most cinematographers rate the Exposure Index of the camera between 400 and 640. As with film, Exposure Index is an artistic decision, and Panavision encourages directors of photography to shoot their own tests to determine the Genesis Exposure Index. If your final product will be a film print, Panavision recommends doing some test film recording as part of your tests, to see the impact of your exposure choices on the entire post-production chain.

22.3 Lighting like you do with film

Many of the directors of photography who work with the Genesis simply light the set like they would do for a film rated at 400 to 640 EI, with one important proviso: all cinematographers notice that the Genesis has more sensitivity in the blacks than film does. The reason is that the CCD is a linear device while film is not.

22. 4 Linear CCD versus non-linear Film

For the most part, each pixel of the CCD acts like an analog linear device – like a light meter. That is, the more light goes in, the more signal comes out.

On the other hand, the whites (shoulder) and blacks (toe) of the film response curve are non-linear:

- In the white areas this means that, above a certain light level, adding more light does not increase the density of the negative much.
- In the dark areas this means that, below a certain light level, dark tones blend together since a dark value yields roughly the same density as an even darker value.

Practically speaking, the CCD's linear response means that you get shadow details with the Genesis that you don't get with film, but you must also be more attentive to over-exposure with Genesis than you would be with film.

22.5 Analog CCD to 14 bit lin

In the Genesis camera, the analog signal from the CCD's pixels are transformed to a digital signal by means of an A to D (Analog to Digital) Converter which outputs a 14 bit digital signal for Red Green and Blue. This 14 bit signal is linear (or "lin"): the more light, the higher the signal.

22.6 14 bit lin = 16 k possible values per pixel

The 14 bit signal defines the latitude, or the number of possible values for each pixel. In a binary system, 14 bits yields 2 to the 14th, or $2 \times 2 \times 2 \times 2 \times 2 \times 2 \times 2 \times 2 \times 2 \times 2 \times 2 \times 2 \times 2 \times 2 \times 2 = 16\,383$ possible values between black and white.

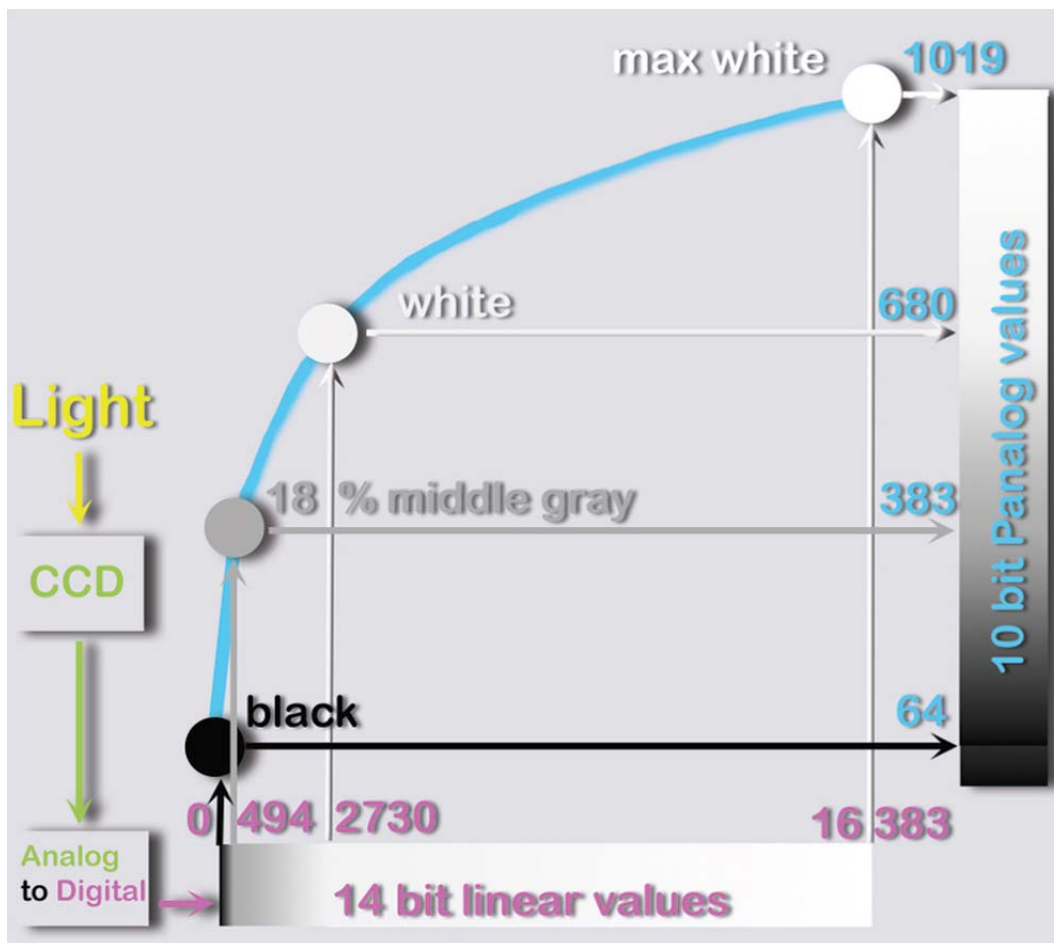

The Panalog transfer curve (in blue) transforms the 14bit linear CCD values to non-linear 10bit log values

22.7 Panalog conversion of 14 bit lin to 10 bit log

Panavision developed a transfer curve, Panalog, to transform the 14 bit lin into a 10 bit quasi-log (or non-linear) signal. Log signals are often used in post-production as a means of using fewer bits to convey the same perceptual information as a lin signal. The Panalog is carefully designed to capture and preserve the entire perceived range of the camera's signal.

22.8 Panalog allocates more to the dark values

The non-linear Panalog transfer curve allocates more values to the darker regions of the image, where our eyes can distinguish more gradations, than to the lighter regions.

The range from black to middle gray goes from 0-494 in 14bit lin which occupies a tiny fraction (about 3%) of the linear scale, but goes from 0-382 in Panalog, almost 40% of the quasi-log scale.

	14 bit lin value	Panalog 10 bit value
range	0 to 16 385	0 to 1 023
Deepest Black	0	64
Middle Gray	494	382
White	2 730	683
Maximum White	16 385	1 019

Note that the Panalog transfer curve still retains a fair amount of “headroom” from the nominal white value of 683 to maximum white of 1019.

The Panalog curve is “perceptually uniform”. That is, the increments in the Panalog value are perceived as linear increments from darkness to white.

22.9 What you see is not necessarily What you get

The image seen on an HD monitor can be misleading. Unlike traditional video or television production, what you see on the monitor with Panalog is not necessarily what you will get in the final product.

The Genesis camera signal is transformed by the Panalog transfer curve to maximize the latitude of the image for subsequent output to 35 mm film. This extended range will not display properly on a video monitor: the image may appear underexposed, low contrast and/or desaturated.

22.10 Panavision Genesis Display Processor

As noted above, the Panalog transfer curve changes the Genesis output signal to obtain maximum latitude. Some DPs simply change the on-set monitor settings to get a rough feeling for the final image. However the Panavision Genesis Display Processor (GDP) unit offers a much better solution by applying a precise Viewing LUT (Look-Up Table) to the signal for viewing on video monitors on the set or in dailies. The GDP converts the Panalog signal to an image that more closely resembles the desired final result on the set, on video projectors for dailies and during down-conversion for the editing process.

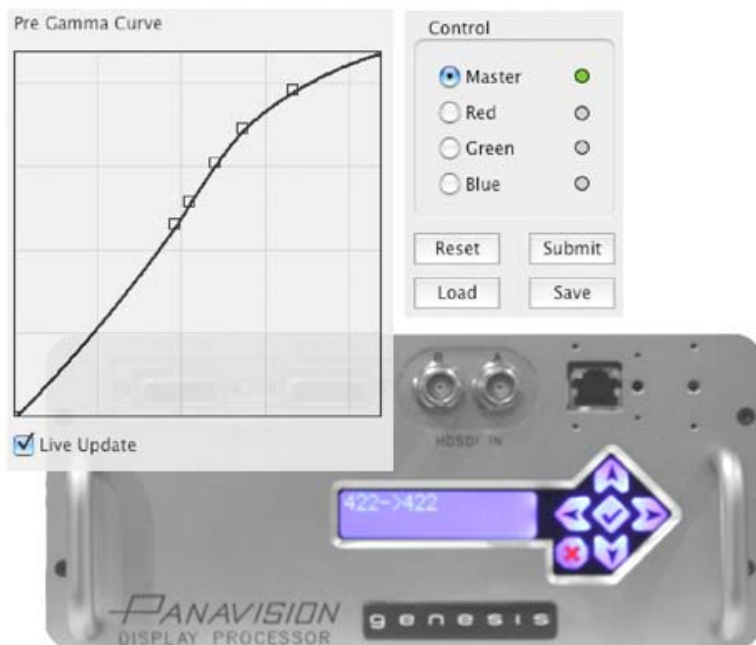

By connecting the GDP to a laptop computer, the cinematographer can load, edit, create and export 3D LUTs for viewing the image properly. The DP can also elect to manipulate the red green and blue gain, pedestal and saturation to previsualize a “Look”, creating an image that gives an indication to the director, editor and crew of the intentions for the final DI. Naturally, it is prudent for the cinematographer to engage the post-production collaborators early

on to establish the best workflow for viewing LUTs, and communicating Looks.

For more information about the Panavision Display Processor and the software for creating, loading and modifying Viewing LUTs, please consult the separate manual available from your Panavision representative.

22.11 Light meters, Monitors and Waveforms

Each cinematographer has his or her own approach to evaluating exposure on a Genesis project, using a combination of different tools: light meters, HD video monitors and waveform monitors.

Some will rely on the light meter, especially when there is no quality video monitoring available, for example when shooting second unit. In this case, it is essential to have done prior exposure tests to set the Genesis EI and latitude.

Many cinematographers will rely principally on a high-quality HD monitor in a dark viewing environment (for example a “Digi Tent” on set) to evaluate the image exposure. If you are shooting for a film finish, Panavision recommends using a Genesis Display Processor that will allow you to pre-visualize the final release print look.

Some cinematographers will also use a waveform monitor for a quick check of video levels, and in particular where the highlights and dark areas fall.

22.12 Panalog white, middle gray and black waveform values

A simple image with white, middle gray, and black elements illustrates Panalog waveform values:

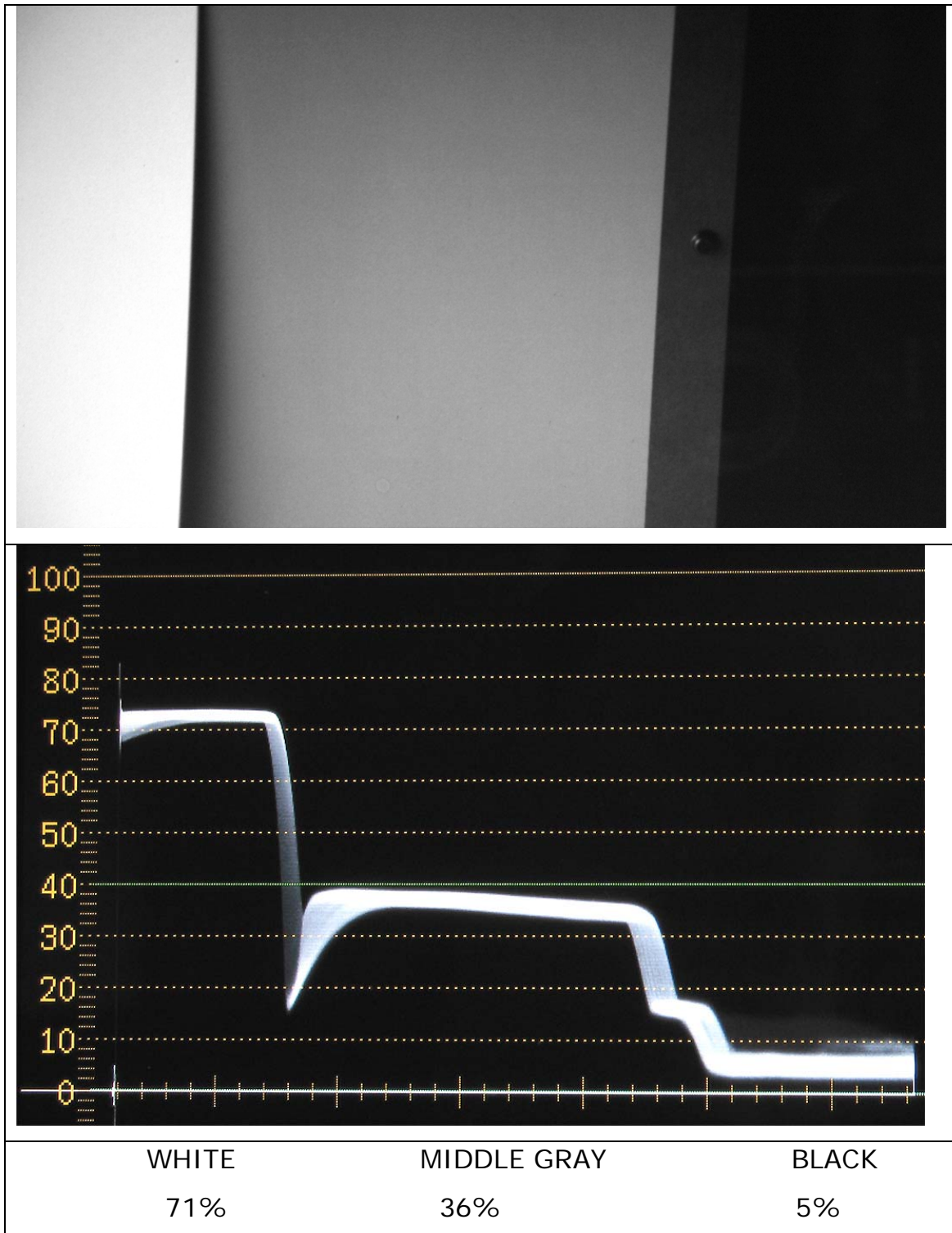

Note that the waveform vertical scale is in percentages NOT voltage.

The area above white gives headroom for overexposure.

22.13 Over-exposure and Under-exposure

With film, cinematographers may over-expose a little bit to get a thicker negative, while with the Genesis they may tend to under-expose a little bit to avoid a clipped video signal. Too much under-exposure, however, will yield a noisy image.

When the Genesis is severely over-exposed (above 100% on the waveform), the whites will be clipped and will lose all detail. This is one rationale for rating the Genesis at 640 EI rather than 500: by slightly underexposing, you are giving even more headroom to the signal.

The danger of underexposure with Genesis is adding video noise to the signal. By underexposing you are lowering the signal and placing your tonal values in the same black area as low-level random noise. As noted below, when you increase the GAIN of the entire signal, you also increase the level of this noise, making it more visible.

22.14 Exposure and Shutter

As with film, a longer exposure time will yield more exposure. Because there is no mechanical shutter in the Genesis, you can set the shutter to openings between 180 and 360 degrees, which is impossible in film. A 360 degree shutter (also known as SHUTTER OFF), yields one more stop of exposure than 180 degree. However a longer exposure time means more motion blur, and cinematographers should be cautious about the loss of sharpness this could entail on close-ups, etc. Panavision recommends testing a range of shutter options to see what works for you.

SHUTTER ON/OFF is controlled via the Genesis LCD menu, see [11.4](#)

22.15 Exposure and GAIN

Increasing the GAIN of the Genesis camera is roughly equivalent to push processing film, you get more apparent sensitivity but with increased noise. When you change the GAIN you are not making the camera more sensitive, but simply amplifying the signal. The drawback is that the low level video noise of the image is increased along with the rest of the signal, and noise becomes more apparent in the image.

Practically speaking many cinematographers have found that 1 stop of gain can be added without impairing the image. Panavision recommends testing a range of Gain options to see what works for you.

GAIN is controlled via the Genesis LCD menu, see **11.4**

23. Panavision Recommended Settings

23.1 Guidelines

23.2 Camera Recording in 444 Format

23.3 Dual-link connection to external SRW-1

23.4 US Features and MOWs at 23.98P

23.5 Progressive Recording

23.6 SQ VTR recording format

23.7 Time Code Record Run or Time of Day

23.8 Syncing with Audio recorder TC

23.9 Unplug external TC for variable speed

23.10 Chip chart at head of every tape

23.11 Panalog conversion data

23.12 Audio analog scratch track and TC

23.1 Guidelines

Many productions new to digital filmmaking ask Panavision for their recommended settings. It is in this spirit that we offer the information in this chapter. However Panavision recognizes that each production has unique requirements, so these guidelines are merely a starting place for the strategy that you will define with your post-production facility.

23.2 Camera Recording in 444 Format

Panavision recommends choosing 444 to record with the Genesis camera when possible, even if your final product is 422.

23.3 Dual-link connection to external SRW-1

If you are using the SRW-1 separated from the Genesis camera, Panavision recommends you connect in “Dual Link” mode with 2 CBLE-BNCH Canare cables or equivalent.

- At speeds of 29.97 fps or below, Dual Link allows you to record 444.
- At speeds over 29.97 fps, the SRW-1 can only record at 422, but Dual Link is required to record the huge amount of data.

In post when making dubs through a SRW-5000/5500 VTR you may choose to output either 4:4:4 Dual Link or 4:2:2 Single Link.

At present, the SRW-1 can only record Selectable variable speed correctly if it is mounted on the Genesis camera. Consult your Panavision technical representative for more information

23.4 US Features and TV at 23.98P

Panavision recommends choosing that US features and TV record at 23.98P, as this will facilitate live down-conversion to NTSC video.

European and Australian features often opt for 24P, while European and Australian Commercials and TV may shoot at 25P.

23.5 Progressive Recording

Panavision does not recommend shooting in the 59.94I or 60I interlace formats, unless you plan to intercut with video cameras, for example for a live event.

23.6 SQ VTR recording format

Panavision recommends the SQ format to record with the Genesis camera. Our testing has shown no real quality gain when using the HQ mode, which uses twice as much tape as SQ.

23.7 Time Code - Record Run or Time of Day

Panavision recommends using Record Run for feature films unless your post-production requests "Time of Day" TC.

Time of Day time code requires an external TC unit, like a Clockit or Denneke.

23.8 Syncing with Audio recorder TC

There are two methods to keep sync with the Time Code from the on-set audio recorder:

1. A time code slate is held in front of the camera or
2. a Clockit or similar external TC device is used to synchronize the camera and sound recorder.

If your production wants you to shoot with an external time code device, you should consult them about time code settings.

23.9 Unplug external TC for variable speed

You must unplug the external TC device when shooting variable speed.

23.10 Chip chart at head of every tape

To help your post house understand your intentions, we recommend that you shoot a properly lit 11 step chip chart at the head of every tape instead of color bars.

23.11 Panalog conversion data

If you are shooting for a film finish, Panavision can provide the data required for converting the Panalog 4 signal for use by editorial, visual effects and other departments.

23.12 Audio analog scratch track and TC

Panavision recommends recording 2 analog feeds from the Audio department:

1. A scratch track recorded on Channel 1
2. An analog LTC (longitudinal time code) with the Audio recorder TC recorded on Channel 2.

24. Genesis Technical Overview

- 24.1 Film-style digital camera
- 24.2 Frame Rates
- 24.3 Lens mount
- 24.4 Accessories
- 24.5 CCD
- 24.6 EI rating
- 24.7 Electronic shutter
- 24.6 LCD Display
- 24.7 Menu controls
- 24.8 Other camera controls
- 24.9 LED Indicators
- 24.10 Digital Viewfinder
- 24.11 Panalog
- 24.12 Video Signal Output
- 24.13 Monitoring
- 24.14 Power
- 24.15 Current Consumption
- 24.16 BNC Connectors/Rear
- 24.17 Other Connectors/Left
- 24.18 Other Connectors/Front
- 24.19 BNC Connectors/Right
- 24.20 Other Connectors/Right
- 24.21 On-board Video Tape Recorder
- 24.22 VTR LCD menu panel (SRWC)
- 24.23 VTR Audio in
- 24.24 VTR BNC connectors
- 24.25 VTR Audio out
- 24.26 Cassettes
- 24.27 Sound Level

24.1 Film-style digital camera

The Genesis is a film-style digital camera that works with existing Panavision 35 mm lenses, and Panaflex accessories. The on-board Sony SRW-1 VTR can be positioned in top or rear position, like a Panaflex magazine. If desired, the camera can be used without the on-board VTR and connected to an external HDSDI recording device.



The Genesis is a film-style digital camera that works with existing Panavision 35 mm lenses, and Panaflex accessories. The on-board Sony SRW-1 VTR can be positioned in top or rear position, like a Panaflex magazine. If desired, the camera can be used without the on-board VTR and connected to an external HDSDI recording device.

24.2 Frame Rates

Genesis fixed speeds are 23.98, 24, 25, 29.97, 30 fps Progressive, and 59.94 and 60 fps Interlace. Variable rate can be set between 1–50 fps. The camera does not currently run in reverse or ramp. Note that, at present, the SRW-1 VTR cannot record 30P or 60I.

24.3 Lens mount

standard Panavision 35 mm mount.

24.4 Accessories

Accepts the entire range of Panaflex accessories including matte boxes, follow focus, etc. Panavision base plate.

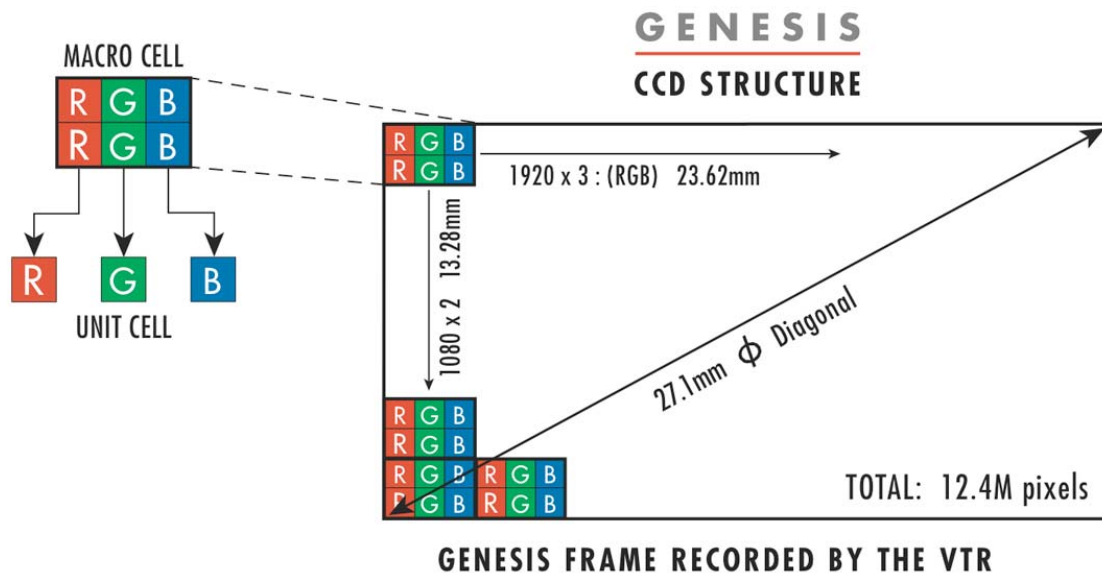

24.5 CCD

12.4 megapixel sensor arranged in a 1920 by 1080 array. Aspect ratio is 1.78:1. CCD comparable in size to a Super 35 mm film frame, with a 27.1 mm diagonal. True 4:4:4 RGB sampling (same number of pixels used for Red, Green and Blue, unlike Bayer pattern), producing maximum resolution for each color. Imaging designed to match wide color gamut of film, to enable seamless inter-cutting of film and Genesis footage.

24.6 EI rating

Cinematographers rate Genesis at an Exposure Index (or ASA) between 500 and 640. The EI doubles when shooting with Electronic Shutter OFF ("360 degrees"). EI can also be increased with Gain (range is -0.5 to +2 stops). Shooting with Shutter OFF and 1 Stop of Gain yields an EI of 2000 to 2560.

24.7 Electronic shutter

Adjustable from 3.8 to 360 degrees.

24.6 LCD Display

programmable menu gives fast access to frequently used camera settings including Auto Black, Shutter Speed, Gain, Variable speed, Electronic Shutter.

24.7 Menu controls

VF/LCD (switch between viewfinder and LCD menus), thumbwheel (menu navigation), status/cancel

24.8 Other camera controls

Recording Start/Stop, 3 assignable switches, On/Off

24.9 LED Indicators

24V 12V Power, Tally, Error, Record

24.10 Digital Viewfinder

Panavision HD color viewfinder with diopter. Option for 2 viewfinders at once. Programmable frame lines and transparent mask.

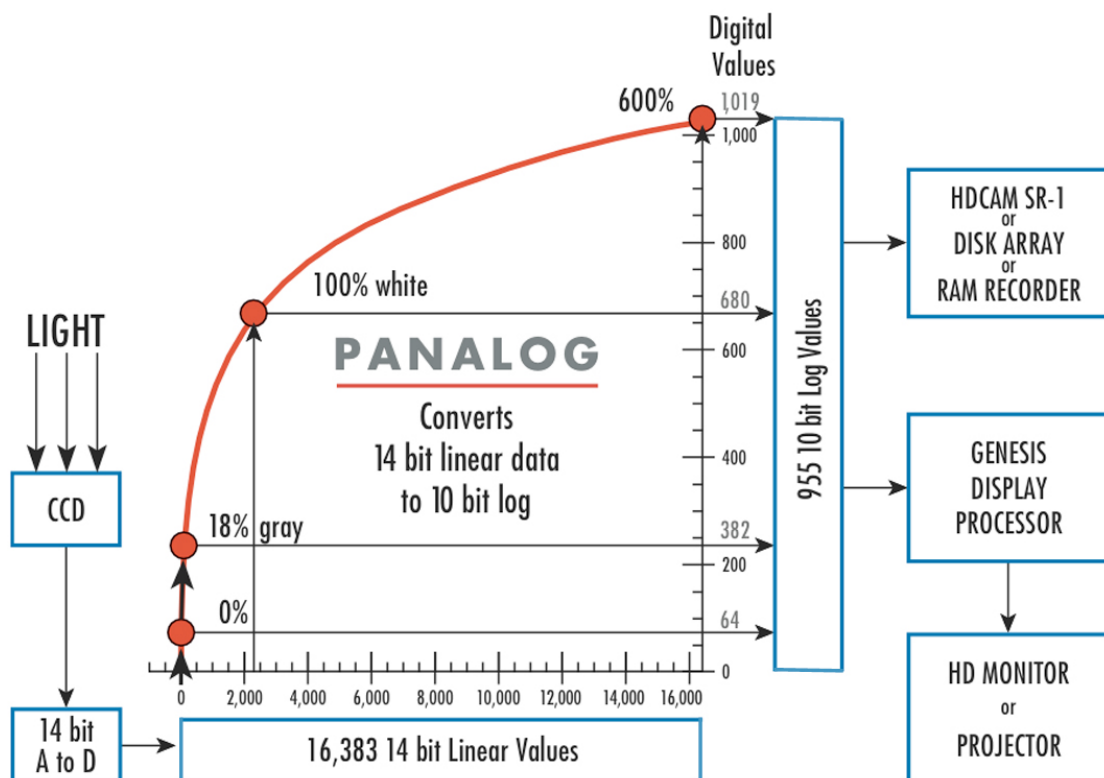

The Panalog curve converts 14 bit lin to 10 bit quasi-log

24.11 Panalog

Panalog© 4 transfer curve changes internal 14 bit linear signal to 10 bit quasi-log output that provides maximum exposure latitude for 35 mm or Digital Cinema release. Panalog creates a perceptually equal grayscale with more values in the darker regions of the image than a linear system.

24.12 Video Signal Output

HDSDI output is 1920 by 1080 pixels in 16:9 aspect ratio, 10 bits per color per pixel. Output available in RGB (4:4:4) or Y, Pb, Pr (4:2:2). Video is fed automatically to VTR through top or rear connector.

24.13 Monitoring

HDSDI output is typically looped through on-board HD monitor to other HD set monitors and down-converters.

24.14 Power

Genesis batteries supply 12V DC (11-17V) for camera and 24V DC (regulated 28V) for accessories.

24.15 Current Consumption

Camera at 30 fps or less: 5Amps, Camera at 30 to 50 fps: 7.5Amps, Sony Viewfinder 0.5Amps, VTR 5Amps, Astro on-board monitor: 1.1 Amps.

24.16 BNC Connectors/Rear

Gen Lock, Reference Out

24.17 Other Connectors/Left

HDRP (for remote start/stop)

24.18 Other Connectors/Front

2 Viewfinder outputs, 12V out, 24 V out, Analog & Digital Zoom motor, 24V iris rod bracket, Focus & T stop motors

24.19 BNC Connectors/Right

Metadata, HD-SDI output. (Dual-link HD-SDI 4:4:4 output with optional GDPL or GADC adaptor in unused VTR connector).

24.20 Other Connectors/Right

Sony multi-pin, RS 232, Power input multi-pin (24V/12V)

24.21 On-board Video Tape Recorder

Sony SRW-1 using HDCAM SR format. SQ or HQ recording modes. VTR connects to camera via docking connector with locking mechanism on top or rear of camera. VTR has its own ON/OFF switch. When docked, VTR is started film-style with Camera start/stop switch. If needed, VTR can be separated from camera and record via BNC in single or dual link HD-SDI mode up to 75 feet away, or 200 feet with a GADC unit.

24.22 VTR LCD menu panel (SRWC)

Plugs into VTR CTRL PANEL via multi-pin cable. Panel latches on to VTR top. Menu system enables many settings including: Time Code hour and Audio levels.

24.23 VTR Audio in

Sony SRW-1 has 2 XLR Audio inputs, typically used to record Audio scratch track and Audio Time Code. Each Audio input has 3-position switch: Line level, Mic level or Mic with phantom 48V power.

24.24 VTR BNC connectors

TC in and TC out.

24.25 VTR Audio out

Earphone stereo mini jack, with volume control.

24.26 Cassettes

Use HDCAM SR cassettes only, maximum running length at 24 fps is 50 minutes.

24.27 Sound Level

Camera only (tethered VTR): 20 dba. Camera with VTR rear mounted: 25 dba. Camera with VTR top mounted: 25.5 dba (all values 3 feet from film plane).

25. Post-production example

Every production uses a slightly different workflow usually defined in collaboration with the sound recordist, editor and post-production facility.

Pictured below are a possible series of steps:

1. On set, the Genesis master videotape is recorded with 2 audio channels fed from the sound recordist: a scratch track and audio time code.
- 2a. The master videotape is copied for safety using 2 HDCAM SR VTRs, such as the Sony SRW-5000 or 5500.
- 2b. The master is fed through a Genesis Display Processor and into a HD video projector for dailies.
3. A copy is fed through a Genesis Display Processor and into a down converter to record standard definition DVD dailies and a videotape dub that will be fed into a non-linear editor (Avid or Final Cut Pro).
4. After an EDL is generated, the post house will transfer takes from the master videotape to be used in DI (digital intermediate), in special effects, and the final film out. The audio is also conformed and mixed in the customary way

Cloning requires either two SRW1s or an SRW1 and a Sony SR5000 or 5500 deck. Panavision recommends that a qualified person keep watch during the duplication process to insure that any mistakes or problems are caught immediately.

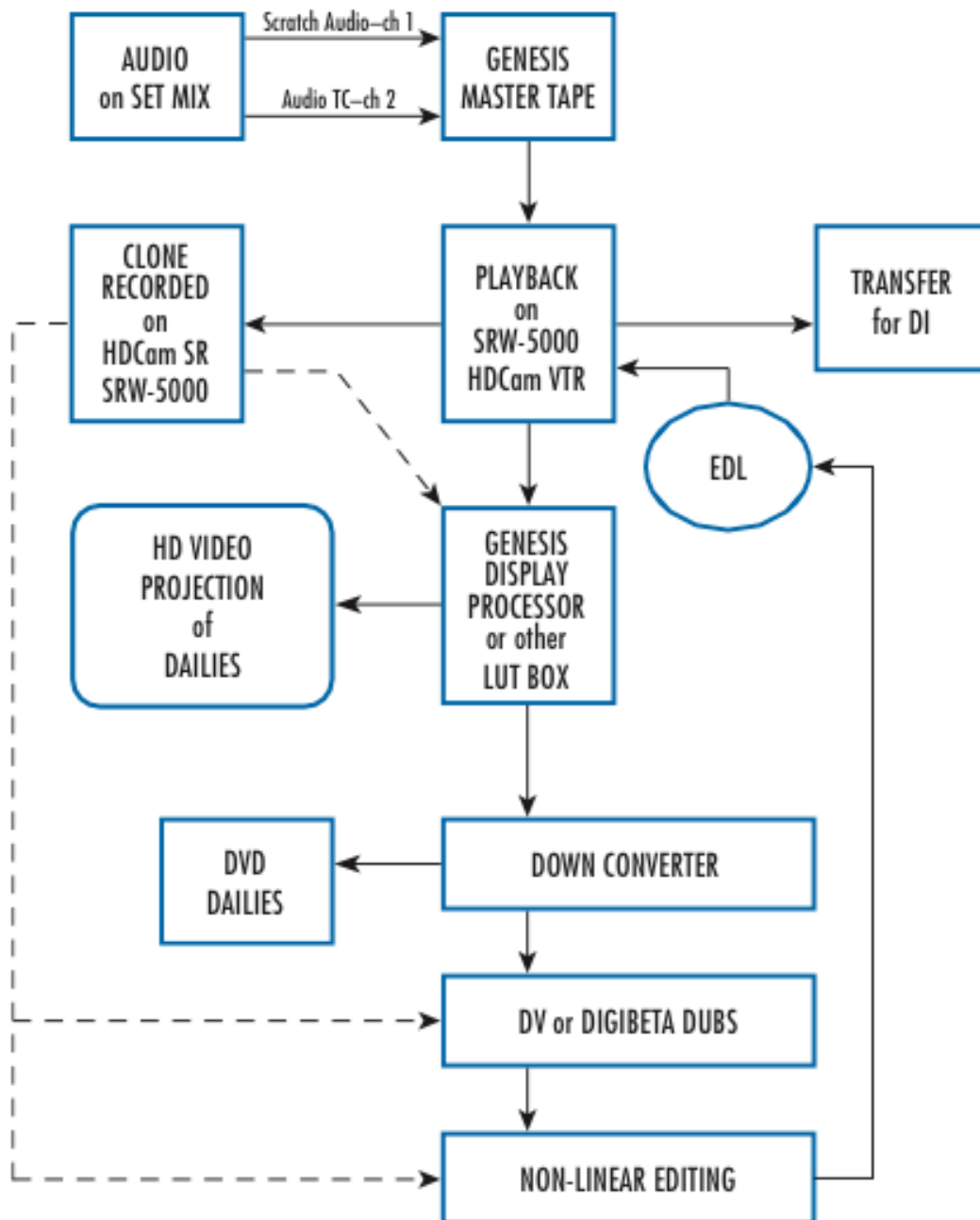

26. All the camera menus

26.1 A word of Caution

26.2 OPERATION menus

26.2 PAINT menus

26.3 MAINTENANCE Menu pages

26.4 FILE Menu pages

27.7 USER Menu pages

28.8 USER MENU CUSTOMIZE pages

26.1 A Word of Caution

If you are shooting for a film finish, the only menus you need to set or check are detailed in **Chapters 11-16**. References to those sections appear in the appropriate menu headings.

For the sake of completeness we are listing all the Camera Menus here. But most of these will not be used unless you are going for a video or television finish.

A word to the wise: don't change a setting you don't completely understand. Changing the wrong setting could put your camera in an unknown state with potentially serious repercussions on your image. If you want a problem-free shoot, it's best to keep Pandora's box closed.

If you do want to try an unusual setting, we strongly suggest that you consult your Panavision representative first.

26.2 OPERATION menus

01 <VF DISPLAY>		See 13.3	
	FOCUS	--	
	T-STOP	OFF	
	ZOOM	--	
	F.TYPE	ON	
	C.FLTR	ON	
	<i>GAIN</i>	ON	
	SHUTT		
	FPS	ON	
	BATT12	OFF	
	BATT24	OFF	
	REC	ON	
	TAPE	OFF	
	MESSAG	ALL	

02 <'!' IND>		See 13.4 for details	
		IND	NORMAL
	WHITE	OFF	PRESET
	GAIN	OFF	0.0
	SHUTTER	OFF	ON
	<i>FORMAT</i>	<i>OFF</i>	23.98PsF
	CHU OUT	OFF	4 : 4 : 4
	FAN	OFF	AUTO 1

03 <MARKER>		See 13.5 for details	
	CENTER TYPE	3	
	SAFETY SIZE	95.0%	
	SHUTTER	OFF	ON
	<i>FORMAT</i>	<i>OFF</i>	23.98PsF
	CHU OUT	OFF	4 : 4 : 4
	FAN	OFF	AUTO 1

O4 <BOX CURSOR>		See 13.6 for details
	H-POSI	50
	V-POSI	50
	WIDTH	95
	HEIGHT	<i>Depends on aspect ratio</i>
	1 2 3 STORE	

O5 <ASPECT MASK>		See 13.8 for details
	VF	OFF
	MONITOR	ON
	MODE	VAR H
	VAR WIDTH	<i>Depends on aspect ratio</i>
	LEVEL	50

O6 <ZEBRA/VF DTL>		
	VF1 ZEBRA	OFF
	VF2 ZEBRA	OFF
	ZEBRA SELECT	1
	ZEBRA1	70%
	ZEBRA2	100%
	VF DTL	25
		ON

O6 is for ZEBRA and DETAIL settings for the viewfinders. The Genesis has 2 separate Zebra patterns that kick in at different highlight levels.

ZEBRAS are diagonal black stripes displayed in the white areas of the image, as a visual indication signal level. Zebras are rarely used in feature films. The cinematographer might use zebra patterns momentarily as a quick check on highlight exposure. Zebras only appear in the viewfinder.

VF1 ZEBRA : turns the Zebras ON or OFF in the first viewfinder
 VF2 ZEBRA : turns the Zebras ON or OFF in the second viewfinder
 ZEBRA SELECT determines which combination of the two Zebras will appear when the Zebras are turned on: 1 or 2 or 1&2
 ZEBRA1 - Dial in the desired signal level for ZEBRA1. With the Panalog4 Genesis signal, 68% refers to nominal white.
 ZEBRA2 - Dial in the desired signal level for ZEBRA2. With the Genesis Panalog signal 100% refers to maximum white.
 VF DETAIL - Dial in the Viewfinder DETAIL level from -99 to 99.
 ON or OFF turns the viewfinder DETAIL on or off.

Note that the Zebra Patterns can be turned on MOMENTarily, OFF or ON by means of the ZEBRA switch on the Viewfinder

07 <BATT ALARM>		
	DC IN (24v)	29.9V
	TYPE: AC ADP	
	BEFORE END:	(22.2V)
	END	(21.6V)
	DC IN (12V)	14.5V
	TYPE:	AC ADP
	BEFORE END:	(11.1V)
	END	(10.8V)

07 displays the voltage levels that will set off battery warnings, and those below which the camera will shut down.

Values in parentheses cannot be changed by user. Batt values are changeable on page M7

The top half concerns the 24 Volt input

The bottom half concerns the 12 Volt input

DC IN indicates the actual current voltage supplied to camera

AC ADP means AC Adapter

BEFORE END is the voltage at which battery warning will appear

END is the voltage at which camera will shut down

O8 <ASSIGNABLE>		See 16.2 for details
	SWITCH1:	FAN MAX
	SWITCH2:	MONI CHAR
	SWITCH3:	REC REVIEW

O9 <OPERATOR FILE>			
	READ (MS ->CAM)		
	WRITE (CAM -> MS)		
	PRESET		
	FILE ID:		
	CAM CODE		
	DATE		

O9 allows you to store or retrieve personalized settings in the Operator Menu pages to and from a Memory Stick. Note this page is identical to page F1

To use a Memory Stick to retrieve or store user defined settings:

1. Insert Memory Stick
2. FILE ID will display user-defined name or 14 blank box characters
3. CAM CODE will display camera type
4. DATE will be displayed

To retrieve previously recorded settings

5a. Click READ (MS->CAM) to retrieve settings from the Memory Stick

To store your current settings

5b1. You have the option to change the FILE ID by clicking alphanumeric characters

5b2. Click WRITE (CAM->MS) to record your setting on to the Memory Stick

To store or retrieve a user-defined Preset file in the camera:

3a. Click PRESET to retrieve the file previously recorded settings

3b. Click STORE PRESET FILE to store the current operator settings in the camera

O10 <LENS FILES>

This page is not used

O11 <VF/MONI OUT>	See 13.9 for details	
	VF1/2	
	OUTPUT:	COLOR
	PV AUTO:	ON
	MONITOR	
	OUTPUT:	COLOR
	PB AUTO:	ON
	VF1 CHARACTER	
	MONI CHARACTER:	OFF

26.3 PAINT Menu pages

P1 <SW STATUS>		See 16.3 for details
	FLARE	OFF
	GAMMA	ON
	BLK GAM	OFF
	KNEE	(OFF)
	WHT CLIP	OFF
	DETAIL	OFF
	LVL DEP	OFF
	SKIN DTL	OFF
	MATRIX	OFF

P2 <VIDEO LEVEL>					
		R	G	B	M
	WHITE	0	0	0	
	BLACK	0	0	0	0
	FLARE	0	0	0	
	GAMMA	--	--	--	--
	FILM TYPE	TUNGSTEN			
	COLOR FILTER	(3200K)			
	FLARE	OFF			
	TEST	OFF			

This page allows users to change different gain parameters for Red, Green, Blue and Master. *Panavision strongly recommends leaving all VIDEO LEVELs at 0.*

FILM TYPE changes the color response of the camera

- TUNGSTEN is used with 3200 Kelvin lighting
- DAYLIGHT is used with daylight or 5600 Kelvin lighting, although some cinematographers will prefer to use an 85 filter in front of or behind the lens.

You can also change Film Type the camera LCD panel. Panavision recommends leaving FLARE OFF

P3 <GAMMA>					
		R	G	B	M
	LEVEL	--	--	--	--
	COARSE	--			
	TABLE	USER			
		<i>PanaLog4</i>			
	GAMMA	ON			
	TEST	OFF			

Note that there are 5 PanaLog4 files labeled PanaLog4_1-5

All Panalog files are identical, there are 5 of them for safety

If a Panalog file becomes damaged, use the next identical Panalog file. Restoring a damaged Panalog file must be done at Panavision.

P4 <BLACK GAMMA>					
	RGB	R	G	B	M
	LEVEL	0	0	0	0
	RANGE	HIGH			
	Y				
	LEVEL	0			
	RANGE	HIGH			
		OFF			
	TEST	OFF			

Panavision recommends leaving the RGB and Y BLACK GAMMA levels OFF.

TEST outputs a test signal for technicians

- OFF normal position
- TEST1 is analog
- TEST2 is digital

P5 <SATURATION>			
	SATURATION	0	
		OFF	
	LOW KEY SAT	-25	
	RANGE	LOW	
		OFF	
	TEST	OFF	

This page controls over-all and dark color saturation levels.

Panavision recommends SATURATION 0 and leaving LOW KEY SAT OFF

TEST outputs a test signal for technicians

- OFF normal position
- TEST1 is analog
- TEST2 is digital

P6 <KNEE>					
		R	G	B	M
	LEVEL	--	--	--	--
	SLOPE	--	--	--	--
	WHT CLP	0	0	0	0
	KNEE	(OFF)			
	KNEE SAT	0		OFF	
	WHT CLIP	OFF			
	TEST	OFF			

The KNEE is a technique used in video and television for changing the slope of the response in the white area of the picture.

Panavision recommends leaving the WHT CLIP OFF

The parentheses indicate that the KNEE is locked in (OFF) when the PANALOG_4 gamma table is selected on page P3

P7 <DETAIL 1>					
		M	WHT	BLK	
	LEVEL	0			
	LIMITER	0	0	0	
	CRISP	0			
	HV RATIO	0			
	FREQ	0			
	LVL DEP	0			
	DETAIL	OFF			
	LVL DEP	OFF			

Detail makes the image appear sharper by increasing the high frequency parts of the signal. Panavision recommends leaving the DETAIL OFF

P8 <DETAIL 2>	
KNEE APERTURE	0
	OFF

Panavision recommends leaving the KNEE APERTURE OFF

P9 <SKIN DETAIL>					
		1	2	3	
	SKIN DTL	OFF			
	SKIN GATE	OFF			
		1	2	3	
	CH SW	(ON)	OFF	OFF	
	GATE	ON	OFF	OFF	
	PHASE	AUTO	AUTO	AUTO	
		0	0	0	
	WIDTH	0	0	0	
	SAT	0	0	0	
	LEVEL	0	0	0	

The aim of these functions is to lower the perceived sharpness in skin tones. Panavision recommends leaving SKIN DTL and SKIN GATE OFF

P10 <USER MATRIX>					
		-R	-G	-B	
	R	--	0	0	
	G	0	--	0	
	B	0	0	--	
		0	0	0	
	MATRIX	OFF			
	PRESET	--			
		--			
	USER MATRIX	--			
	MULTI MATRIX	--			

The USER MATRIX changes the color rendition of the camera.

Panavision strongly recommends leaving the MATRIX OFF

P11 <MULTI MATRIX>		
	PHASE	0
	HUE	0
	SAT	0
		ALL CLEAR
	MATRIX	OFF
	PRESET	--
	USER MATRIX	--
	MULTI MATRIX	--

The MULTI MATRIX changes the color rendition of the camera.

Panavision strongly recommends leaving the MATRIX OFF

P12 <SHUTTER>		
	SHUTTER	ON
		Your choice
	ECS ANGLE	Your choice

The SHUTTER and ECS menu items are more easily accessed on the LCD menu panel on the camera body. See [11.4](#)

P13 <SCENE FILE>	
	1 2 3 4 5 STORE
	STANDARD
	READ (MS ->CAM)
	WRITE (CAM ->MS)
	FILE ID
	CAM CODE
	DATE

P13 is for transfer to allows you to transfer scene file settings to or from in-camera files. Genesis does not use Memory Sticks. This page is identical to page F2. The Scene file stores all the settings in the preceding 12 Paint Menu pages

To restore the Panavision Default scene settings

1. Click on STANDARD

To Store a Scene File in 1 of 5 camera memory files

1. Click on STORE
2. Click the file number to store to 1 2 3 4 5

To retrieve a Scene File from 1 of 5 camera memory files

1. Click the file number to retrieve from: 1 2 3 4 5

P14 <SELECT FPS>		See 16.5
	FORMAT	23.98PsF
	FPS	Your variable speed fps choice
	VIDEO LEVEL	CONST (GAIN)
	VF SCAN	NORMAL

26.4 MAINTENANCE Menu pages

M1 <AUTO SETUP>	
	AUTO BLACK
	AUTO WHITE
	AUTO LEVEL
	AUTO BLACK SHADING

M1 is for automatic adjustments of black level, white balance, gain and black shading. *Panavision recommends that you do not use this page.*

The AUTO BLACK function is used often, but is better accessed directly on the LCD Menu Panel. See [11.6](#)

M2 <WHITE SHADING>				
		R	G	B
	V SAW	0	0	0
	V PARA	0	0	0
	H SAW	0	0	0
	H PARA	0	0	0
	WHITE	0	0	0

This page changes the spatial linearity of the white shading.

WARNING: Changing these parameters could make your image unusable. Panavision strongly recommends that you not touch these settings

M3 <BLACK SHADING>					
		R	G	B	M
	V SAW	0	0	0	
	V PARA	0	0	0	
	H SAW	0	0	0	
	H PARA	0	0	0	
	BLK SET	0	0	0	
	BLACK	0	0	0	0
	MASTER GAIN	0.0			

	AUTO BLACK SHADING	
	IRIS CLOSE	OFF

This page changes the spatial linearity of the black shading, the black level and the master gain.

WARNING: Changing these parameters could make your image unusable. Panavision strongly recommends that you not touch these settings

M4 <OHB MATRIX>		
	PHASE	0
	HUE	0
	SAT	0
	ALL CLEAR	
	OHB MATRIX	OFF
	MATRIX	OFF

This page changes the color rendition of the camera.

WARNING: Changing these parameters could make your image unusable. Panavision strongly recommends that you not touch these settings

M5 <CAM ID/DATE>		
	CAM ID	
	DATE/TIME	
	01/01/2008	07:41

M5 allows you to input a CAMera ID and to set the DATE/TIME

M6 <MULTI FORMAT>		See Chapter 14	
	CURRENT	444	your choice
	NEXT	444	Next choice
	SET FORMAT		
	23.98PsF	24PsF	
		25PsF	
	29.97PsF	30PsF	

S29.97PsF	S30PsF
-----------	--------

M7 <BATT ALARM SET>	
DC IN (24v)	29.9V
TYPE: AC ADP	
BEFORE END:	(22.2V)
END	(21.6V)
DC IN (12V)	14.5V
TYPE: AC ADP	
BEFORE END:	(11.1V)
END	(10.8V)

M7 is similar to OPERATION page 07

Note: Because of the camera high current draw, changing BEFORE END values will not appreciably alter the time between the battery warning and camera shutdown

M8 <ABERRATION>				
Ra	0	Ba	0	
Rb	0	Bb	0	
Rc	0	Bc	0	
Rd	0	Bd	0	
ABERRATION COMP: OFF				

M8 compensates for color aberrations. Panavision recommends that you leave this menu unchanged.

M9 <OTHERS 1>	
H PHASE	0
COLOR BAR	OFF
	HD-SMPTE

M9 changes H phase with regard to an incoming video reference, and controls color bar type and output.

To synchronize the shutters of multiple cameras, take Genlock out of 1 camera and loop through the others. Do not put a Genlock in to the first camera. See 4.17

The H PHASE control is for technician use only.

COLOR BAR ON and OFF is more easily accessed by using the LCD Menu Panel on the camera body. See 11.4

Panavision recommends using HD-SMPTE color bars because they permit setting the black level on the monitor accurately. See 10.8

While color bars are useful for setting monitors and checking video levels, Panavision recommends shooting 11 step linear chip charts for post-production calibration.

M10 <OTHERS 2>	See 16.6	
	FAN MODE	AUTO1
	MENU RESUME	ALL
	DATE TYPE	5 M/D/Y
	IMAGE INVERT	OFF
	LANGUAGE	FILM
	LCD CONTRAST	3
	MONO CHAR	OFF

M11 <CA OUTPUT>		
	BNC OUT SEL	VTR

M11 controls the output of a future optional Fiber Channel Camera Adaptor

26.5 FILE Menu pages

F1 <OPERATOR FILE>	
	READ (MS ->CAM)
	WRITE (CAM->MS)
	PRESET
	STORE PRESET FILE
	FILE ID
	CAM CODE
	DATE

F1 is identical to OPERATION Menu page O9

F2 <SCENE FILE>	
	1 2 3 4 5 STORE
	STANDARD
	READ (MS ->CAM)
	WRITE (CAM->MS)
	FILE ID
	CAM CODE
	DATE

F2 is identical to PAINT Menu page P13

F3 <REFERENCE FILE>	
	STORE FILE
	STANDARD
	READ (MS ->CAM)
	WRITE (CAM->MS)
	FILE ID
	CAM CODE
	DATE

F3 allows you to transfer reference settings to or from the in-camera memory. (Genesis does not use Memory Sticks). *Panavision recommends that you not use this page.*

F4 <USER GAMMA>	
	READ (MS -> CAM)
	PRESET
	FILE ID
	CAM CODE
	DATE

This function is not available on Genesis.

F5 <LENS FILE>	
	STORE FILE
	No: 1
	NAME: NO OFFSET
	F NO: F1.0
	LENS AUTO RECALL: OFF
	CENTER MARKER
	H POS: 0
	V POS: 0
	STORE CENTER

F5 is not commonly used

To change the stored CENTER MARKER (e.g. cross hair) position:

1. Select a new H POS and/or V POS value
2. Click on STORE CENTER

A de-centered marker could be used as a visual reference point for special effects, etc...

The appearance of CENTER MARKER and its visibility are controlled on page O3 of the Operation Menu

F6 <OHB FILE>	
----------------------------	--

	STORE FILE
--	------------

F6 is not used.

F7	<FILE CLEAR>
	PRESET OPERATOR
	REFERENCE (ALL)
	LENS(CURRENT)
	OHB WHITE SHADE
	OHB BLACK SHADE
	OHB BLACK SET
	OHB MATRIX
	MS FORMAT

WARNING: Changing these parameters would make your image unusable. Panavision strongly recommends that you not touch these settings

26.7 DIAGNOSIS Menu pages

D1 <VTR/CA STATUS>	
	DOCKING
	TOP : NONE
	REAR: VTR

D1 confirms the VTR connection, and indicates which port the VTR is connected to.

D2 <ROM VERSION>			
	ROM		
	SY: V1.10		
	PLD		
	TG	V_ . _ _	
	PRE12		
	PRE3		
	FRAME12		
	SFCONV		
	POST		
	TR		

D2 indicates menu software version numbers.

D3 <ROM VERSION>			
	<CAM>		
	OHB:	OK	
	PP:	OK	
	FM:	OK	
	PR:	OK	
	IF:	OK	
	AD:	OK	
	TR:	OK	

This troubleshooting page indicates the status of the circuit boards

D4 <SDI>	
	OPTICAL LEVEL: NO SIGNAL

D4 is not used.

26.8 USER Menu pages

U1 <MULTI FORMAT>		See Chapter 14	
	CURRENT	444	your choice
	NEXT	444	Next choice
	SET FORMAT		
	23.98PsF	24PsF	
		25PsF	
	29.97PsF	30PsF	
	S29.97PsF	S30PsF	

The Panavision default for this user programmable page is a copy of the MULTI FORMAT page. See also **15.1**

26.9 USER MENU CUSTOMIZE pages

U1 <PAGE EDIT>		See 15.2	
	1 :	<MULTI FORMAT>	
	2.:	-----	
	...		
	8.:	-----	
	9.:	-----	

This page defines the pages copied to the USER Menu

U2 <USER P1 EDIT>		See 15.4	
	AUTO BLACK		
	COLOR BAR SW:	OFF	
	SHUTTER SPEED:	Your choice	deg
	ECS FREQ	Your choice	deg
	FILM TYPE	3200K	
	MASTER GAIN	0.0	
	FPS	Your variable speed choice	
	SHUTTER	ON	

This page defines the Genesis LCD Menu items

27. All the VTR menus

27.1 A word of caution

**27.2 VTR TIME CODE Menus - Recommended settings
(Internal TC)**

27.3 VIDEO Menus

27.4 VTR AUDIO Menus - Recommended settings

27.5 VTR SYSTEM Menus - Recommended settings

27.6 Diagnosis Menu

27.1 A word of caution



If you are shooting for a film finish, the only menus you need to set or check are detailed in [Chapters 17-19](#). References to those sections appear in the appropriate places.

For the sake of completeness we are listing all the SRW-1 VTR Menus here. But most of these will not be used unless you are going for a video or television finish.

A word to the wise: don't change a setting you don't completely understand. Changing the wrong setting could put your VTR in an unknown state with potentially serious repercussions on your image. If you want a problem-free shoot, it's best to keep Pandora's box closed.

If you do want to try an unusual setting, we strongly suggest that you consult your Panavision representative first.

27.2 VTR TIME CODE Menus - Recommended settings (Internal TC)

Panavision recommends the following VTR Time Code menu settings when shooting with Internal Time Code. You should consult your post-production house about these settings.

Assuming Internal Time Code

TIME CODE	TIMER SEL	TC	
	TIMER RESET		
	TIMER PRESET	TCG TC	
	TCR SEL	AUTO	
	TCG MODE	PRST	
	<i>REGEN SRC</i>	<i>INT L</i>	
	RUN MODE	R RUN	
	TCG SET(MAIN)	DF/NDF UBG SRC 12H/24H	Non Drop Frame TCG Source 24 H
	Others(Main)	TC OUT RT REC RT SET LTC Delay VITC Delay	Auto VITC 0 0
	PD TC		

TIMER SEL = Type of time data displayed on HOME menu

TCG = Time Code Generator

TCR = Time Code Reader

TCG MODE PRST = TCG in Preset mode. TC recording will begin with the Preset value (as opposed to Regen or Real Time)

REGEN SRC = Source for Regenerated TC. In Regen mode TC recording continues the TC previously recorded on preceding take.

R RUN = Record Run mode. In Record Run TC only increments during recording. The result is continuous TC during playback. (The alternative is Real Time TC which records the “time of day”).

UBG = User Bit Generator

RT = Real Time

LTC = Longitudinal Time Code

VITC = Vertical Interval Time Code

If your production requires external Time Code, consult your post-Production supervisor about connections to an external TC generator and their desired TC settings.

27.3 VTR VIDEO Menus- Recommended settings

When the SRW-1 VTR is mounted on the Genesis camera, the VIDEO menu is empty.

When the SRW-1 VTR is separated from the camera body and mounted on the Sony SRPC unit, as described in [Chapter 21](#), the following options appear in the VIDEO menu. This menu defines the kind of signals that will be routed to the HD SDI and SD SDI MONITOR OUTputs of the SRPC (See [21.11](#)), and also the type of video input.

VIDEO	PD (MON)	OUTPUT	AUTO
	DC	TYPE POS(EC)	LB
	MON SEL(x2)	TYPE	LINKA
	VIDEO I/O	VA INPUT	SDI

PD (MON) – 3/2 PullDown selection for MON HD SDI output of the Sony SRPC “Toaster”

AUTO – automatically performs pulldown conversion when speed is 23.98

DC – DownConversion options for SD SDI MONITOR OUT

TYPE LB - LetterBox

POS(EC) – doesn’t apply to LetterBox output

MON SEL(x2) TYPE LINKA – When a 422 Dual connection is made, the HD-SDI A signal is routed to the HD SDI MONITOR OUT connector of the SRPC “Toaster”

VIDEO I/O VA INPUT SDI – Selects the HD SDI input when the SRW-1 is mounted on the SRPC Toaster (see [Chapter 21](#))

27.4 VTR AUDIO Menus - Recommended settings

Panavision recommends the following Audio menu settings.

AUDIO	Input Sel	Track1 Track 2	Analog CH1 Analog CH2
	Phone SEL	CH 1 CH 2	Left Right
	Mix Mode	RMS	
	Rec Level	CH1 CH2	VAR VAR
	PB Level	CH1 CH2	UNI UNI
	Meter Type	Full Peak	
	Peak Hold	On	
	Beep (Phone)	Alarm Warn	Off Off
	Input Delay	No Delay	

You should consult the Sound Department, and the Production Mixer about these settings.

27.5 VTR SYSTEM Menus - Recommended settings

SYSTEM	FORMAT	LINE FRAME SIGNAL SELECT FPS FPS FORMAT (SET)	1080P <i>your frame rate</i> 444SQ or 422 OFF or ON DEF
	REFERENCE	Mode	Input
	TEST SG	Video Audio	Off Off
	LCD	Light Off Bright Saver Saver Msg	Disable 20 Disable
	KEY MAP	all	Disable
	KEY INHI	MAP	
	REMOTE/LOCAL	LCL	
	SERVO	Stby Off Tracking <i>Adjust</i>	30sec UNITY
	REC INHI	OFF	
	EDIT		
	POWER	MODE	EE
	BATTERY	BATT TYPE Near End End	LI-Ion 13.0 11.0
	OTHERS	SOFT VERSION HOURS METER FORMAT LIST OPTION LIST	

LINE = Number of lines in Video frame

1080P = 1080 lines Progressive format

FRAME = Recording format the menu options are:

23.98	50
24	59.94
25	60
29.97	

444SQ = 4:4:4 Standard Quality use for every fixed speed of 30 or below and for S29.97, S30 variable speed ranges

422 = 4:2:2 use for 50, 59.94, 60 fixed speeds and S59.94 and S60 variable speed ranges

422x2 = is 2 422 signals combined for 3D work

FPS FORMAT DEF = Default format when recording with Selectable speed ranges

(SET) = Change recording format to selected one. Reboots VTR.

TEST SG = Test Signal Generator

LCD = Liquid Crystal Display

KEY INHI = Key Inhibit

REMOTE/LOCAL = option to control the VTR by device connected to REMOTE input on the SRPC (this menu item only appears when SRW-1 is connected to SRPC Toaster)

Stby Off = Standby Off Timer, time it will take before VTR automatically exits Standby mode

REC INHI = Record Inhibit

BATT TYPE LI-Ion = Battery Type Lithium Ion

BATTERY Near End = Battery voltage at which VTR will start Battery warnings

BATTERY End = Battery voltage at which VTR will shut off

SOFT VERSION = software version

Naturally, you should consult with your post-production house about your frame rate.

28. Quick reference to key sections

Genesis Camera System

- 3.1 Cases
- 4.1 Camera left side controls
- 4.3 Assignable controls
 - 1. FAN MAX ON/OFF
 - 2. MONitor CHARacter ON/OFF
 - 3. RECord REVIEW
- 4.4 RECORD button
- 4.12 Camera front
- 4.14 Camera right side
- 4.15 Removing the handle
- 4.17 Camera POWER switch
- 4.17 GEN LOCK

Genesis viewfinder

- 5.1 Assembling viewfinder
- 5.3 Viewfinder controls
- 5.4 Other viewfinder controls
- 5.7 Viewfinder diopter

Sony SRW-1 VTR

- 6.2 VTR configurations
- 6.3 VTR connectors & switches
- 7.1 To separate the SRWC from the VTR
- 7.2 SRWC HOME screen
- 7.6 Putting VTR in STANDBY OFF
- 8.1 To mount SRW-1 to rear port of Genesis camera
- 8.2 To remove VTR from rear port
- 8.3 To insert a cassette

Powering the Genesis

- 9.4 Battery indicator
- 9.7 To charge a battery
- 9.9 Using the GPS Genesis power supply

Video monitoring

- 10.1 Genesis 4 video outputs
- 10.4 Video connections on the set
- 10.5 Astro on-board HDAM monitor
- 10.6 Astro front buttons
- 10.7 Astro back connectors
- 10.8 To adjust your monitor using color bars

The Camera LCD menu

- 11.3 menu vf/lcd switch
- 11.3 Using thumbwheel with LCD menus
- 11.4 LCD menu defaults:
 - COLOR BAR SW
 - SHUTTER SPEED
 - ECS FREQ
 - MASTER GAIN
 - FILM TYPE
 - FPS (variable speed)
 - SHUTTER ON/OFF
- 11.5 To do a BLACK BALANCE

The Camera viewfinder menu

- 12.5 Using thumbwheel to navigate Viewfinder menus
- 12.11 To change a viewfinder menu setting
- 13.6 Setting frame lines
- 14.7 To change fixed speed format

SRW-1 VTR menus

- 17.1 VTR menu navigation
- 18.2 To change Time Code hour before new tape
- 18.3 Recommended Time Code settings (internal TC only)
- 19.4 To adjust audio recording level
- 19.8 To adjust earphone channels
- 19.9 Recommended Audio menu settings

Variable speed

- 20.11 To turn STANDBY OFF
- 20.12 To shoot variable speed with VTR mounted on Genesis

Camera Separated from VTR

- 21.2 To mount SRW-1 on top of SRPC
- 21.3 To unmount SRW-1 from SRPC
- 21.4 To power the SRPC and SRW-1
- 21.6 To connect Genesis dual-link video to the SRPC
- 21.10 To change SRW-1 format
- 21.11 To change SRW-1 format using format list
- 21.12 SRPC connector panel

Before you shoot

- 22.12 Panalog waveform
- 23.1 Panavision recommended settings

Reference

- 24.1 Genesis Technical Overview
- 25.1 Post-production example
- 26.1 All the camera menus
- 27.1 All the VTR menus

